

# ***Hydrotech***®

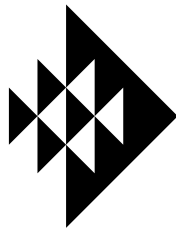

**PENTEK**®  
Pentair Water

## **Filtration Products**

Please refer to the Price List to identify if the product you're ordering is a 'Stocked' or 'Non-Stocked' item.

- Stocked Items (STK) are commonly purchased and cover most application requirements. WaterGroup will ensure ample stock is available at our facilities to fulfill orders within 2 business days.
- Special order Items (-) are infrequently ordered but may be required under certain circumstances. Special Order Items will be filled within 20 calendar days.
- Possible stock substitute items (\*) are stocked items that may replace a special order item. We have provided a cross-reference indicating similar 'Stocked Items' that may be substituted at your discretion depending on the application requirements.

---

## Pentek® Filtration Products

---

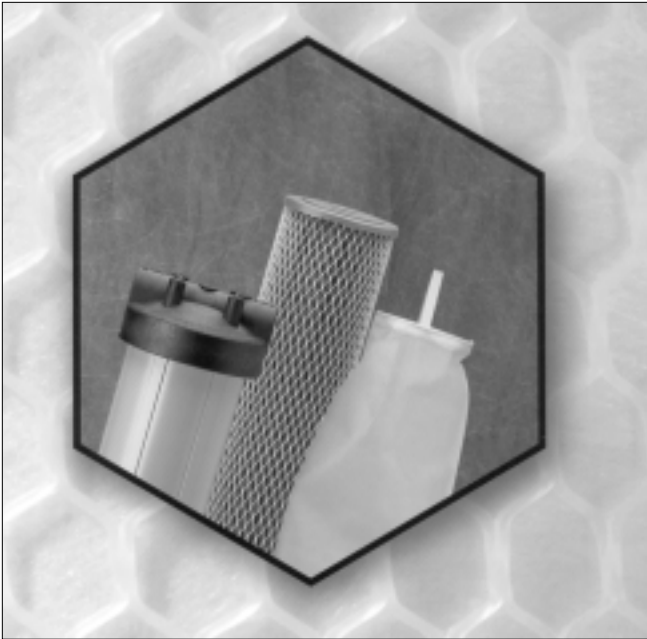

### ***What kind of cartridge filter do I need?***

You need to determine what specific concerns you have about your water (lead? chlorine? sodium? poor taste and odor?). If you're not sure, then find out the quality of the water entering your home. If you are on a community water supply, call your water company and ask them to send you a water quality report. If your water comes from a private well, you will need to have your water tested by a reputable laboratory. Once you have determined how your water can be improved, our Customer Service Department can help you determine what water filtration solution best fits your needs. Here are some general guidelines:

#### **Sediment**

3/4" standard or valve-in-head filter housing with sediment cartridge

#### **Sediment, Whole House**

1" and 1-1/2" Big Blue® Filter Housing with sediment cartridge

#### **Chlorine, Whole House**

1" and 1-1/2" Big Blue® Filter Housing with radial-flow carbon filter cartridge (RFC Series)

#### **Taste/Odor/Chlorine**

1/4", 3/8" or 1/2" SlimLine™ Filter Housing with carbon filter cartridge

#### **Point-of-Use**

Countertop Drinking Water Filter • Undersink Drinking Water Filtration System • Faucet Filter • Shower Filter

### ***What can I do about iron stains?***

To determine the correct method of removal, it is important to know which type of iron is present.

**Soluble Iron** - also known as ferrous iron or clear-water iron - is clear in running water but will settle to the bottom as black or rust-colored particles when it is allowed to stand. When it contacts air, it may precipitate and stain. Soluble iron cannot be filtered out but may be reduced with a cation-exchange water softener.

**Insoluble Iron** - also known as ferric iron or visible iron - is suspended in water and is clearly visible as "rusty" water. You should be able to see small black or rust-colored particles in your water as soon as it comes out of your tap before you've allowed it to sit. Insoluble iron may be reduced with a sediment filter. If you have a water softener, be sure to place the sediment filter before the water softener.

### ***My water smells like rotten eggs. Can I get a filter to improve this problem?***

That "rotten egg" smell is actually caused by harmless bacteria which produce hydrogen sulfide gas. These bacteria can't be removed with a cartridge filter.

### ***I have a well and I want to install a sediment filter. What filter cartridge can I use?***

You will need to use a synthetic sediment filter cartridge such as a Pentek Filtration P5 and CW-F cartridge. Pleated cellulose cartridges such as the Pentek S1 Series cartridges are NOT resistant to the harmless bacteria that are found in many well water supplies.

# Standard Filter Housings

- Ideal for a wide range of applications, including residential, commercial and industrial.
- Available in 10" and 20" sizes to meet your needs.
- Optional pressure-relief/bleed button on inlet side of cap.
- Thick walls for increased strength.
- Leak-proof sealing with top-seated Buna-N O-ring.
- Available with clear and blue sumps.

Standard filter housings are manufactured of a durable polypropylene or clear Styrene-Acrylonitrile (SAN). All are equipped with 3/4" NPT inlet and outlet ports.

Reinforced polypropylene housings have excellent chemical resistance and are ideal for many residential, commercial and industrial applications. Clear sumps are manufactured from a clear, FDA-approved Styrene-Acrylonitrile (SAN) and offer on-site examination of the cartridge.

Standard filter housings are available in both 10" and 20" lengths and will accommodate a wide range of 2-1/2" and 2-7/8" diameter cartridges.



MB=Mounting Boss Cap



COMPONENT

The 150001, 150002, 150067, 150068, 150072, 150435 and 150436 are Tested and Certified by NSF International under NSF/ANSI Standard 42 for material and structural integrity requirements only.

Item #	Description	Maximum Dimensions	Initial ΔP (psi) @ Flow Rate (gpm)
150067	#10 BLUE Standard, 3/4" In/Out, w/p.r., w/m.b.c.	12-1/4" x 5-1/8" (311 mm x 130 mm)	1 psi @ 10 gpm (0.1 bar @ 3.8 lpm)
150068	#10 BLUE Standard, 3/4" In/Out, wo/p.r., w/m.b.c.		
150071	#10 CLEAR/BLUE CAP Standard, 3/4" In/Out, w/p.r., w/m.b.c.	12-5/8" x 5-1/4" (321 mm x 133 mm)	1 psi @ 10 gpm (0.1 bar @ 3.8 lpm)
150072	#10 CLEAR/BLUE CAP Standard, 3/4" In/Out, wo/p.r., w/m.b.c.		
150435	#10 CLEAR/BLACK CAP Standard, 3/4" In/Out, w/p.r., w/m.b.c.		
150436	#10 CLEAR/BLACK CAP Standard, 3/4" In/Out, wo/p.r., w/m.b.c.	22-3/8" x 5-1/8" (568 mm x 130 mm)	1 psi @ 10 gpm (0.1 bar @ 3.8 lpm)
150069	#20 BLUE Standard, 3/4" In/Out, w/p.r., w/m.b.c.		
150070	#20 BLUE Standard, 3/4" In/Out, wo/p.r., w/m.b.c.		

## Materials of Construction

- **Housing** .....Polypropylene (Blue)  
Styrene-Acrylonitrile (Clear)
- **Cap** .....Reinforced Polypropylene
- **Button Assembly** ....300-series Stainless Steel, EPDM and Polypropylene
- **O-Ring** .....Buna-N
- **Maximum Temperature** .....125°F (51.7°C)
- **Maximum Pressure** .....125 psi (8.62 bar)

**CAUTION:** Protect against freezing to prevent cracking of the filter and water leakage.

---

## Slim Line® Filter Housings

---

- Slim design reduces space required for installation without sacrificing capacity.
- FDA Grade
- Optional pressure relief button on inlet side of cap.
- Leak-proof seal with top-seated O-ring.
- Available with clear or opaque sumps.

Slim Line® filter housings are available in either reinforced polypropylene or clear Styrene-Acrylonitrile (SAN) in 5", 10" and 20" lengths. The black or blue reinforced polypropylene housing caps are available with 1/4", 3/8" or 1/2" NPT connections. Four bosses are molded into every cap for mounting purposes.

Slim Line® filter housings are an excellent choice for low-flow applications and when space and chemical compatibility are primary concerns.

**Clear Slim Line® Filter Housings** offer on-site examination of flow, performance and cartridge life. They are ideal for a variety of applications. Manufactured of clear Styrene-Acrylonitrile (SAN), the sumps are stress relieved for added clarity and strength. The blue polypropylene caps can be ordered with an optional pressure-relief button on the inlet side to relieve pressure inside the housing when changing filter cartridges.

**Opaque Slim Line® Filter Housings** are molded from rugged reinforced polypropylene, Opaque Slim Line® filter housings offer outstanding chemical compatibility and are ideal for use in a variety of low-flow applications. These applications include under-sink and countertop residential filtration, pre- and post-reverse osmosis filtration, recreational vehicle filtration, food service, humidifying systems. They are equipped with a black, reinforced polypropylene cap and can be ordered with an optional pressure-relief button on the inlet side to relieve pressure inside the housing when changing filter cartridges.



COMPONENT

The 158005, 158006, 158114, 158120, 158125, 158126, 158128, 158129, 158131, 158149, 158195, 158204 and 158205 are Tested and Certified by NSF International to NSF/ANSI Standard 42 for material and structural integrity requirements only.

# Slim Line® Filter Housings Specifications & Performance Data

Item #	Description	Maximum Dimensions	Initial ΔP (psi) @ Flow Rate (gpm)
158138	#5 BLUE/BLACK CAP Slim Line™, 1/4" In/Out, wo/p.r.	7" x 4-3/8" (178 mm x 111 mm)	2 psi @ 3 gpm (0.14 bar @ 11 lpm)
158133	#5 CLEAR/BLUE CAP Slim Line™, 1/4" In/Out, wo/p.r.	7-3/8" x 4-5/8" (187 mm x 118 mm)	
158002	#5 BLUE/BLACK CAP Slim Line™, 3/8" In/Out, w/p.r.	7" x 4-3/8" (178 mm x 111 mm)	2 psi @ 5 gpm (0.14 bar @ 19 lpm)
158003	#5 BLUE/BLACK CAP Slim Line™, 3/8" In/Out, wo/p.r.		
158110	#5 CLEAR/BLUE CAP Slim Line™, 3/8" In/Out, w/p.r.	7-3/8" x 4-5/8" (187 mm x 118 mm)	
158111	#5 CLEAR/BLUE CAP Slim Line™, 3/8" In/Out, wo/p.r.		
158115	#10 BLUE/BLACK CAP Slim Line™, 1/4" In/Out, w/p.r.	11-3/4" x 4-3/8" (299 mm x 111 mm)	2 psi @ 3 gpm (0.14 bar @ 11 lpm)
158114	#10 BLUE/BLACK CAP Slim Line™, 1/4" In/Out, wo/p.r.		
158117	#10 CLEAR/BLUE CAP Slim Line™, 1/4" In/Out, w/p.r.	12-1/8" x 4-5/8" (308 mm x 118 mm)	
158116	#10 CLEAR/BLUE CAP Slim Line™, 1/4" In/Out, wo/p.r.		
158326	#10 CLEAR/WHITE CAP Slim Line™, 1/4" In/Out, wo/p.r.	11-3/4" x 4-3/8" (299 mm x 111 mm)	
158120	#10 BLACK/BLACK CAP Slim Line™, 1/4" In/Out, wo/p.r.		
158182	#10 WHITE/WHITE CAP Slim Line™, 1/4" In/Out, w/p.r.		
158125	#10 WHITE/WHITE CAP Slim Line™, 1/4" In/Out, wo/p.r.		
158179	#10 WHITE/WHITE COUNTERTOP 1/4" In/Out		
158005	#10 BLUE/BLACK CAP Slim Line™, 3/8" In/Out, w/p.r.	11-3/4" x 4-3/8" (299 mm x 111 mm)	
158006	#10 BLUE/BLACK CAP Slim Line™, 3/8" In/Out, wo/p.r.		
158007	#10 CLEAR/BLUE CAP Slim Line™, 3/8" In/Out, w/p.r.	12-1/8" x 4-5/8" (308 mm x 118 mm)	
158008	#10 CLEAR/BLUE CAP Slim Line™, 3/8" In/Out, wo/p.r.		
158149	#10 WHITE/WHITE CAP Slim Line™, 3/8" In/Out, w/p.r.	11-3/4" x 4-3/8" (299 mm x 111 mm)	
158098	#10 WHITE/WHITE CAP Slim Line™, 3/8" In/Out, wo/p.r.		
158195	#10 BLUE/BLACK CAP Slim Line™, 1/2" In/Out, w/p.r.	11-3/4" x 4-3/8" (299 mm x 111 mm)	2 psi @ 5 gpm (0.14 bar @ 19 lpm)
158196	#10 BLUE/BLACK CAP Slim Line™, 1/2" In/Out, wo/p.r.		
158214	#10 CLEAR/BLUE CAP Slim Line™, 1/2" In/Out, w/p.r.	12-1/8" x 4-5/8" (308 mm x 118 mm)	
158215	#10 CLEAR/BLUE CAP Slim Line™, 1/2" In/Out, wo/p.r.		
158129	#20 BLUE/BLACK CAP Slim Line™, 3/8" In/Out, wo/p.r.	21-7/8" x 4-3/8" (556 mm x 111 mm)	2 psi @ 5 gpm (0.14 bar @ 19 lpm)
158204	#20 BLUE/BLACK CAP Slim Line™, 1/2" In/Out, w/p.r.	21-7/8" x 4-3/8" (556 mm x 111 mm)	2 psi @ 5 gpm (0.14 bar @ 19 lpm)
158205	#20 BLUE/BLACK CAP Slim Line™, 1/2" In/Out, wo/p.r.		

## Materials of Construction

- **Housing** .....SAN (Clear) or Polypropylene (Opaque)
- **Cap** .....Reinforced Polypropylene
- **Button Assembly** ....300-series Stainless Steel, EPDM and Polypropylene
- **O-Ring** .....Buna-N
- **Maximum Temperature** .....125°F (51.7°C)
- **Maximum Pressure** .....125 psi (8.62 bar)

**CAUTION:** Protect against freezing to prevent cracking of the filter and water leakage.

## 3G Standard Filter Housings

We took our time-tested industry standard and made it even better. We started from the ground up, utilizing our 35 years of experience, to create the unique and innovative Third Generation (3G) design. This patent pending design features integral brackets, 20" clear housings, and caps for differential pressure gauges. The new patent pending 3G housing accepts standard double open end (DOE) and our Seal-Safe™ O-ring sealing cartridges (only available on Microguard Cartridges). The new Seal-Safe™ O-ring design offers enhanced cartridge sealing for critical cartridge applications. You can be assured the Third Generation Standard Filter Housing will set the new standard and keep you in the lead.

- Integral bracket versions available.
- Available in 10" and 20" sumps in clear and opaque.
- Buttress threads and uniform walls for easier cartridge change and improved strength.
- Accepts proprietary Seal-Safe™ double O-ring sealing cartridges as well as standard DOE cartridges.
- Cap is available with threaded ports for mounting differential pressure gauge.
- Choice of with or without pressure-relief/bleed button.
- Leak-proof sealing with top-seated floating Buna-N O-ring.

US Patent No. D 455,194 S and D 456,486 S.

3G Standard Filter Housings are manufactured from a durable polypropylene or clear Styrene-Acrylonitrile (SAN). All are equipped with 3/4" NPT inlet and outlet ports.

Reinforced polypropylene housings have excellent chemical resistance and are ideal for many residential, commercial and industrial applications. Clear sumps are manufactured from a clear, FDA compliant Styrene-Acrylonitrile (SAN). They offer on-site examination of the cartridge and have excellent chemical compatibility as well.

3G Standard Filter Housings are available in both 10" and 20" lengths and will accommodate a wide range of 2-1/4" to 3-1/8" diameter cartridges.



\*Shown with differential gauge. Gauges sold separately.

### Standard Mounting Boss Caps

- Can be used with MC-1A bracket kit.
- Differential pressure gauges cannot be used with these housings.



MB Cap W/PR



MB Cap W/PR



IB Cap W/PR



IB Cap W/PR



MM Cap W/PR

### Integral Mounting Bracket Caps

- Optional screw kit for integral bracket, part number 150580 sold separately.
- Differential pressure gauges cannot be used with these housings.

### Integral Bracket Meter Mount Caps

- Optional screw kit for integral bracket sold separately.
- Cap contains predrilled and tapped holes for mounting differential pressure gauges.

CAUTION: Housing will not hold pressure without an installed differential pressure gauge.

## 3G Standard Filter Housings

Item #	Description	Maximum Dimensions	Initial ΔP (psi) @ Flow Rate (gpm)
<b>Standard Mounting Boss Caps</b>			
150542	3G #10 ST BK/BL 3/4" MB w/p.r., Blue Housing	12-3/4" x 5-3/8" (324 mm x 137 mm)	1 psi @ 10 gpm (0.07 bar @ 38 lpm)
150546	3G #10 ST BK/BL 3/4" MB, Blue Housing		
150544	3G #20 ST BK/BL 3/4" MB w/p.r., Blue Housing	23" x 5-3/8" (584 mm x 137 mm)	1 psi @ 10 gpm (0.07 bar @ 38 lpm)
150548	3G #20 ST BK/BL 3/4" MB, Blue Housing		
150558	3G #10 ST BL/CL 3/4" MB w/p.r., Clear Housing	12-3/4" x 5-3/8" (324 mm x 137 mm)	1 psi @ 10 gpm (0.07 bar @ 38 lpm)
150562	3G #10 ST BL/CL 3/4" MB, Clear Housing		
150587	3G #10 ST BK/CL 3/4" MB w/p.r., Clear Housing		
150560	3G #20 ST BL/CL 3/4" MB w/p.r., Clear Housing	23" x 5-3/8" (584 mm x 137 mm)	1 psi @ 10 gpm (0.07 bar @ 38 lpm)
150564	3G #20 ST BL/CL 3/4" MB, Clear Housing		
<b>Integral Mounting Bracket Caps</b>			
150550	3G #10 ST BK/BL 3/4" IB w/p.r., Blue Housing	13-1/4" x 5-3/4" (337 mm x 146 mm)	1 psi @ 10 gpm (0.07 bar @ 38 lpm)
150554	3G #10 ST BK/BL 3/4" IB, Blue Housing		
150552	3G #20 ST BK/BL 3/4" IB w/p.r., Blue Housing	23-1/2" x 5-3/4" (597 mm x 146 mm)	1 psi @ 10 gpm (0.07 bar @ 38 lpm)
150556	3G #20 ST BK/BL 3/4" IB, Blue Housing		
150566	3G #10 ST BL/CL 3/4" IB w/p.r., Clear Housing	13-1/4" x 5-3/4" (337 mm x 146 mm)	1 psi @ 10 gpm (0.07 bar @ 38 lpm)
150570	3G #10 ST BL/CL 3/4" IB, Clear Housing		
150568	3G #20 ST BL/CL 3/4" IB w/p.r., Clear Housing	23-1/2" x 5-3/4" (597 mm x 146 mm)	1 psi @ 10 gpm (0.07 bar @ 38 lpm)
150572	3G #20 ST BL/CL 3/4" IB, Clear Housing		
<b>Integral Bracket Meter Mount Caps</b>			
150574	3G #10 ST BK/BL 3/4" MM w/p.r., Blue Housing	13-1/4" x 5-3/4" (337 mm x 146 mm)	1 psi @ 10 gpm (0.07 bar @ 38 lpm)
150576	3G #20 ST BK/BL 3/4" MM w/p.r., Blue Housing	23-1/2" x 5-3/4" (597 mm x 146 mm)	1 psi @ 10 gpm (0.07 bar @ 38 lpm)

\*Height does not include meter. Add 1-3/4" for 143549 gauge and 1/2" for 143550 gauge.

### Key

ST = Standard	MB = Mounting Bosses for MC-1A bracket	W/PR = With Pressure Release
BK = Black	IB = Integral Bracket	(blank) = Without Pressure Release
BL = Blue	MM = Meter Mount for Differential Pressure Gauges	
CL = Clear	BT = British Threads	

### Materials of Construction

- **Housing** ..... Polypropylene (Opaque)  
Styrene-Acrylonitrile (Clear)
- **Cap** ..... Reinforced Polypropylene
- **Button Assembly** ..... 300-series Stainless Steel,  
polypropylene and EPDM
- **O-Ring** ..... Buna-N
- **Maximum Temperature** ..... 125°F (51.7°C)
- **Maximum Pressure** ..... 125 psi (8.62 bar)

**CAUTION:** Filter must be protected against freezing, which can cause cracking of the filter and water leakage.

---

## 3G Slim Line® Standard Filter Housings

---

- 10-inch housings available with clear or opaque sump
- Buttress threads for additional strength and easier cartridge changes
- John Guest and NPT threaded connections offered in 1/4-inch, 3/8-inch, and 1/2-inch
- Cap styles include mounting boss, integral bracket, meter mount and optional pressure relief bleed valve
- Housing accepts our proprietary Seal-Safe™ double o-ring sealing cartridges as well as DOE (double open end) cartridges
- Leak-proof sealing with a top-seated floating Buna-N o-ring

Slim Line® housings are the perfect choice for low-flow filtration applications. Their slim design and high chemical compatibility make them ideal for those challenging applications.

Caps are manufactured from reinforced polypropylene in black, blue, and white. Standard NPT threaded and John Guest connections are available with 1/4-inch, 3/8-inch and 1/2-inch connections. Three different style caps add to the flexibility of these housings.

The mounting boss cap features bosses molded in to the cap. This allows the housing to be mounted to a single bracket or a multiple housing bracket.

The integral bracket cap does not require a separate bracket as the bracket is part of the cap. This feature saves valuable time during installation.

Take the guesswork out of when to change your cartridge by using the meter mount cap. These gauges indicate when the cartridge is dirty and allow you to get the most out of your cartridges.

U.S. Patent No. D 455,194 S and D 456,486 S

Pressure relief buttons are another option with the Slim Line® 3G housings. Placed on the inlet side, the pressure-relief button helps reduce the pressure in the housing when changing the cartridge.

Housings are available with either clear or opaque sumps. The clear housings are manufactured of Styrene-Acrylonitrile (SAN) and are stress relieved through a special process for added strength and clarity. Clear housings offer on-site examination of the flow, cartridge life and performance.

Opaque housings are molded from reinforced polypropylene and offer outstanding chemical compatibility.

Typical applications for the 3G Slim Line® housings include, but are not limited to, undersink residential filtration, pre- and post reverse osmosis systems, recreational vehicle filtration, and food service.





## 3G Slim Line® Standard Filter Housings

Item #	Description	Maximum Dimensions	Initial ΔP (psi) @ Flow Rate (gpm)
<b>3G Slim Line® Housings (Cap Sump) - 1/4-inch NPT, Mounting Boss Housings</b>			
158597	#10 3G Slim Line® Black/Blue 1/4" MB w/o pr	12-1/2" x 4-5/8" (318 mm x 118 mm)	2 psi @ 3 gpm (0.14 bar @ 11 L/min)
158598	#10 3G Slim Line® Black/Blue 1/4" MB w/pr		
158599	#10 3G Slim Line® Blue/Clear 1/4" MB w/o pr		
158600	#10 3G Slim Line® Blue/Clear 1/4" MB w/pr		
158601	#10 3G Slim Line® White/White 1/4" MB w/o pr		
<b>3G Slim Line® Housings (Cap Sump) - 1/4-inch John Guest Quick Connect, Mounting Boss Housings</b>			
158602	#10 3G Slim Line® Black/Blue 1/4" QC MB w/o pr	12-1/2" x 4-5/8" (318 mm x 118 mm)	2 psi @ 5 gpm (0.14 bar @ 19 L/min)
158603	#10 3G Slim Line® Black/Blue 1/4" QC MB w/pr		
158604	#10 3G Slim Line® Blue/Clear 1/4" QC MB w/o pr		
158606	#10 3G Slim Line® White/White 1/4" QC MB w/o pr		
158607	#10 3G Slim Line® White/White 1/4" QC MB w/pr		
<b>3G Slim Line® Housings (Cap Sump) - 1/4-inch NPT, Integral Bracket Housings</b>			
158636	#10 3G Slim Line® Black/Blue 1/4" IB w/pr	13-3/8" x 5-3/8" (340 mm x 137 mm)	2 psi @ 3 gpm (0.14 bar @ 11 L/min)
158637	#10 3G Slim Line® Blue/Clear 1/4" IB w/pr		
158638	#10 3G Slim Line® White/White 1/4" IB w/pr		
<b>3G Slim Line® Housings (Cap Sump) - 1/4-inch John Guest Quick Connect, Integral Bracket Housings</b>			
158639	#10 3G Slim Line® Black/Blue 1/4" QC IB w/pr	13-3/8" x 5-3/8" (340 mm x 137 mm)	2 psi @ 3 gpm (0.14 bar @ 11 L/min)
158640	#10 3G Slim Line® Blue/Clear 1/4" QC IB w/pr		
158641	#10 3G Slim Line® White/White 1/4" QC IB w/pr		
<b>3G Slim Line® Housings (Cap Sump) - 3/8-inch NPT, Mounting Boss Housings</b>			
158608	#10 3G Slim Line® Black/Blue 3/8" MB w/o pr	11-3/4" x 4-3/4" (298 mm x 121 mm)	2 psi @ 5 gpm (0.14 bar @ 19 L/min)
158609	#10 3G Slim Line® Black/Blue 3/8" MB w/pr		
158610	#10 3G Slim Line® Blue/Clear 3/8" MB w/o pr		
158611	#10 3G Slim Line® Blue/Clear 3/8" MB w/pr		
158613	#10 3G Slim Line® White/White 3/8" MB w/o pr		
158612	#10 3G Slim Line® White/White 3/8" MB w/pr		
<b>3G Slim Line® Housings (Cap Sump) - 3/8-inch John Guest Quick Connect, Mounting Boss Housings</b>			
158614	#10 3G Slim Line® Black/Blue 3/8" QC MB w/o pr	11-3/4" x 4-3/4" (298 mm x 121 mm)	2 psi @ 5 gpm (0.14 bar @ 19 L/min)
158616	#10 3G Slim Line® Blue/Clear 3/8" QC MB w/o pr		
158619	#10 3G Slim Line® White/White 3/8" QC MB w/o pr		
158618	#10 3G Slim Line® White/White 3/8" QC MB w/pr		
<b>3G Slim Line® Housings (Cap Sump) - 3/8-inch NPT, Integral Bracket Housings</b>			
158642	#10 3G Slim Line® Black/Blue 3/8" IB w/pr	13-3/8" x 5-1/4" (340 mm x 133 mm)	2 psi @ 5 gpm (0.14 bar @ 19 L/min)
158643	#10 3G Slim Line® Blue/Clear 3/8" IB w/pr		
<b>3G Slim Line® Housings (Cap Sump) - 3/8-inch John Guest Quick Connect, Integral Bracket Housings</b>			
158645	#10 3G Slim Line® Black/Blue 3/8" QC IB w/pr	13-3/8" x 5-1/4" (340 mm x 133 mm)	2 psi @ 5 gpm (0.14 bar @ 19 L/min)
158646	#10 3G Slim Line® Blue/Clear 3/8" QC IB w/pr		
158647	#10 3G Slim Line® White/White 3/8" QC IB w/pr		
<b>3G Slim Line® Housings (Cap Sump) - 1/2-inch NPT, Mounting Boss Housings</b>			
158620	#10 3G Slim Line® Black/Blue 1/2" MB w/o pr	11-3/4" x 4-3/4" (298 mm x 121 mm)	2 psi @ 5 gpm (0.14 bar @ 19 L/min)
158621	#10 3G Slim Line® Black/Blue 1/2" MB w/pr		
158622	#10 3G Slim Line® Blue/Clear 1/2" MB w/o pr		
158623	#10 3G Slim Line® Blue/Clear 1/2" MB w/pr		
<b>3G Slim Line® Housings (Cap Sump) - 1/2-inch John Guest Quick Connect, Mounting Boss Housings</b>			
158625	#10 3G Slim Line® Black/Blue 1/2" QC MB w/pr	12-1/2" x 4-5/8" (318 mm x 118 mm)	2 psi @ 5 gpm (0.14 bar @ 19 L/min)
158626	#10 3G Slim Line® Blue/Clear 1/2" QC MB w/o pr		
<b>3G Slim Line® Housings (Cap Sump) - 1/2-inch NPT, Integral Bracket Housings</b>			
158648	#10 3G Slim Line® Black/Blue 1/2" IB w/pr	13-3/8" x 5-3/8" (298 mm x 121 mm)	2 psi @ 5 gpm (0.14 bar @ 19 L/min)
158649	#10 3G Slim Line® Blue/Clear 1/2" IB w/pr		
<b>3G Slim Line® Housings (Cap Sump) - 1/2-inch John Guest Quick Connect, Integral Bracket Housings</b>			
158650	#10 3G Slim Line® Black/Blue 1/2" QC IB w/pr	13-3/8" x 5-3/8" (298 mm x 121 mm)	2 psi @ 5 gpm (0.14 bar @ 19 L/min)
158651	#10 3G Slim Line® Blue/Clear 1/2" QC IB w/pr		
<b>3G Slim Line® Housings (Cap Sump) - 1/2-inch NPT or Quick Connect, Integral Bracket Meter Mount Housings</b>			
158656	#10 3G Slim Line® Black/Blue 1/2" IB MM <sup>1</sup> w/pr	13-3/8" x 5-3/8" (298 mm x 121 mm)	2 psi @ 5 gpm (0.14 bar @ 19 L/min)
158657	#10 3G Slim Line® Black/Blue 1/2" QC IB MM <sup>1</sup> w/pr		

<sup>1</sup> Housing is not designed to operate without an installed differential pressure gauge. Gauge must be purchased separately. See Pentek Accessories page.

# Big Blue® Filter Housings

- Large capacity housings suitable for high flow applications.
- Available in 10" and 20" sizes to meet your needs.
- Optional pressure relief/bleed on inlet side of cap.
- Accepts 4-1/2" diameter cartridges.

Big Blue® filter housings offer the versatility to meet all your large-capacity filtration needs, including high flow and heavy sediment applications. The extra large housing allows for greater cartridge capacity, reducing the number of vessels required for high flow rate applications. Sumps are constructed of durable reinforced polypropylene and are available in 10" and 20" lengths.

The high flow polypropylene (HFPP) cap is available with 3/4", 1" or 1-1/2" NPT inlet and outlet ports. The 1-1/4" internal port allows a greater volume of liquid to pass through the HFPP cap more rapidly.

Big Blue® housings are compatible with a broad range of chemicals and are available with or without an optional pressure relief button. They accept a wide variety of 4-1/2" diameter cartridges in either 10" or 20" lengths.



The 150233, 150234, 150235, 150236, 150237, 150238, 150239, 150240, 150467 and 150469 are Tested and Certified by NSF International to NSF/ANSI Standard 42 for material and structural integrity requirements only.

Item #	Description	Maximum Dimensions	Initial ΔP (psi) @ Flow Rate (gpm)
150469	#10BB Big Blue®, 3/4" In/Out, w/p.r.	13-1/8" x 7-1/4" (333 mm x 184 mm)	2 psi @ 15 gpm (0.1 bar @ 57 lpm)
150470	#10BB Big Blue®, 3/4" In/Out, wo/p.r.		
150237	#10BB Big Blue®, 1" In/Out, w/p.r.	13-1/8" x 7-1/4" (333 mm x 184 mm)	1 psi @ 15 gpm (0.1 bar @ 57 lpm)
150238	#10BB Big Blue®, 1" In/Out, wo/p.r.		
166219	#10BB Big Clear, 1" In/Out, w/p.r.	13- 5/8" x 7-1/4" (346 mm x 184 mm)	1 psi @ 20 gpm (0.1 bar @ 76 lpm)
150239	#10BB Big Blue®, 1 1/2" In/Out, w/p.r.		
150240	#10BB Big Blue®, 1 1/2" In/Out, wo/p.r.		
150233	#20BB Big Blue®, 1" In/Out, w/p.r.	23- 3/8" x 7-1/4" (594 mm x 184 mm)	1 psi @ 15 gpm (0.1 bar @ 57 lpm)
150234	#20BB Big Blue®, 1" In/Out, wo/p.r.		
166201	#20BB Big Clear, 1 1/2" In/Out, w/p.r.	23-7/8" x 7- 1/4" (606 mm x 184 mm)	1 psi @ 20 gpm (0.1 bar @ 76 lpm)
150235	#20BB Big Blue®, 1 1/2" In/Out, w/p.r.		
150236	#20BB Big Blue®, 1 1/2" In/Out, wo/p.r.		

## Materials of Construction

- **Housing** .....Polypropylene
- **Cap** .....Polypropylene (HFPP)
- **Button Assembly** .....300-series Stainless Steel, EPDM and Polypropylene
- **O-Ring** .....Buna-N
- **Maximum Temperature** .....100°F (37.7°C)
- **Maximum Pressure** .....#10BB - 100 psi (6.9 bar)  
#20BB - 90 psi (6.2 bar)

**CAUTION:** Protect against freezing to prevent cracking of the filter and water leakage.

# Valve-In-Head Filter Housings

- Ideal for a wide range of applications, including residential, commercial and industrial.
- Available in 10" and 20" sizes.
- Optional pressure-relief/bleed button on inlet side of cap.
- Thick walls for increased strength.
- Leak-proof sealing with top-seated Buna-N O-ring.
- Available with clear and blue sumps.

Valve-in-head housings incorporate the same rugged design and application features as our Standard 3/4" NPT housings.

The internal valve-in-head allows both inlet and outlet ports to be simultaneously shut-off with a half turn of the handle. This eliminates the need for external shut-off valves. Radial sealing O-rings and sealing surfaces are continuously cleaned each time the valve is used, ensuring leak-proof operation.

Valve-in-head filter housings are available in 10" and 20" lengths, will accommodate a wide range of 2-3/8" and 2-7/8" diameter cartridges and are available with either reinforced polypropylene or clear FDA-compliant Styrene-Acrylonitrile (SAN) sumps.



COMPONENT

The 150164 and 150172 are Tested and Certified by NSF International to NSF/ANSI Standard 42 for material and structural integrity requirements only.

Item #	Description	Maximum Dimensions	Initial ΔP (psi) @ Flow Rate (gpm)
150164	#10 BLUE Valve-In-Head, 3/4" In/Out, w/p.r.	12 1/2" x 5 1/8" (318 mm x 130 mm)	4 psi @ 8 gpm (0.3 bar @ 30 lpm)
150437	#10 CLEAR Valve-In-Head, 3/4" In/Out, w/p.r.	12 7/8" x 5 1/4" (327 mm x 133 mm)	4 psi @ 8 gpm (0.3 bar @ 30 lpm)
150166	#20 BLUE Valve-In-Head, 3/4" In/Out, w/p.r.	22 5/8" x 5 1/8" (575 mm x 130 mm)	4 psi @ 8 gpm (0.3 bar @ 30 lpm)

## Materials of Construction

- **Housing** ..... Polypropylene (Blue)  
Styrene-Acrylonitrile (Clear)
- **Cap** ..... Reinforced Polypropylene
- **Button Assembly** .... 300-series Stainless Steel, EPDM and Polypropylene
- **Valve Parts** ..... Delrin
- **O-Ring** ..... Buna-N
- **Maximum Temperature** ..... 125°F (51.7°C)
- **Maximum Pressure** ..... 125 psi (8.62 bar)

**CAUTION:** Protect against freezing to prevent cracking of the filter and water leakage.

# High Temperature Filter Housings

- Ideal for a wide range of industrial applications.
- Excellent alternative to stainless and carbon steel vessels.
- Durable glass-reinforced nylon construction.

Constructed of glass-reinforced nylon. High temperature filter housings are an economical alternative to stainless and carbon steel housings.

These 1/2" and 3/4" NPT housings can withstand temperatures up to a maximum of 160°F (71.1°C). Excellent chemical compatibility makes High Temperature housings an ideal choice for a wide variety of industrial applications including those involving organic solvents, sea water, alcohol, petroleum and vegetable oils. They should not be used with ketones.

A #241 Viton O-ring provides dependable sealing. Both 10" and 20" lengths are available to accommodate flow rates up to 20 gpm (76L/min.).



Item #	Description	Maximum Dimensions	Initial ΔP (psi) @ Flow Rate (gpm)
158319	#10 BLACK High Temperature Slim Line® 1/2" In/Out, wo/p.r.	11-3/4" x 4-3/8" (298 mm x 111 mm)	5 psi @ 8 gpm (<0.4 bar @ 30 lpm)
150015	#10 RED High Temperature Standard, 3/4" In/Out, wo/p.r.	12-1/8" x 5-1/8" (308 mm x 130 mm)	<1 psi @ 8 gpm (0.1 bar @ 30 lpm)
150111	#20 RED High Temperature Standard, 3/4" In/Out, wo/p.r.	22-1/4" x 5-1/8" (565 mm x 130 mm)	

## Materials of Construction

- **Housing** .....Glass-Reinforced Nylon
- **Cap** .....Glass-Reinforced Nylon
- **O-Ring** .....Viton®
- **Maximum Pressure** ....125 psi (8.6 bar)
- **Maximum Temperature** .....160°F (High Temp.)  
160°F (High Temp.)  
Slim Line®)

**CAUTION:** Protect against freezing to prevent cracking of the filter and water leakage.

# Bag Vessel Assemblies

- Lightweight, corrosion-resistant, polypropylene construction gives you strength without weight.
- Available in 1" and 1-1/2" NPT sizes.
- Comes complete with gauge, wrench and 3/8" drain valve.
- Choice of 10" and 20" housings.
- Light enough to be portable.

Pentek's standard bag vessel assemblies keep your system on stream longer by reducing bag filter change time.

The single large Acme thread closure ensures quick opening and positive sealing.

All PBH Series vessels come complete with gauge, wrench and 3/8" drain valve.

PBH Series bag vessel assemblies are made of lightweight, corrosion-resistant, polypropylene to give you all the strength you need without the weight.

Bag vessel assemblies are economically priced, allowing you to install a duplex system for totally uninterrupted flow rates.

Bags are available in polypropylene felt, absolute-rated high-efficiency polypropylene and nylon monofilament mesh - ideal for filtering and straining applications from 1 to 800 microns.



**PBH-410**  
(shown with bag vessel stand)  
**Item #150370**  
**PBH & BB Housing Stand**

Item #	Description	Maximum Dimensions	Initial ΔP (psi) @ Flow Rates (gpm)	Maximum Pressure
150360	PBH-410 (1")	13-1/8" x 7-1/4" (333mm x 184mm)	1 psi @ 15 gpm (0.1 bar @ 56.8 lpm)	100 psi (6.9 bar)
150338	PBH-410 (1 1/2")	13-5/8" x 7-1/4" (346 mm x 184 mm)	1 psi @ 20 gpm (0.1 bar @ 75.7 lpm)	100 psi (6.9 bar)
150367	PBH-420 (1")	23-3/8" x 7-1/4" (594mm x 184mm)	1 psi @ 15 gpm (0.1 bar @ 56.8 lpm)	90 psi (6.2 bar)
150337	PBH-420 (1 1/2")	23-7/8" x 7-1/4" (606mm x 184mm)	1 psi @ 20 gpm (0.1 bar @ 75.7 lpm)	90 psi (6.2 bar)

- PBH-410 accepts a standard 4" x 8-1/4" (102 mm x 210 mm) bag. Dimensions allow for 1" (25 mm) overlap on basket.
- PBH-420 accepts a standard 4" x 18-1/2" (102 mm x 470 mm) bag. Dimensions allow for 1" (25 mm) overlap on basket.

## Materials of Construction

- **Housing** ..... Polypropylene
- **Cap** ..... Polypropylene
- **Gauge** ..... Bismuth Brass (lead free)
- **Vent Plug** ..... Polypropylene
- **Drain Plug** ..... High Density Polypropylene
- **Ball Valve** ..... PVC/Buna-N Seals
- **Basket** ..... Polypropylene
- **O-Ring and Gaskets** ..... Buna-N
- **Maximum Temperature** ..... 100°F (37.8°C)

**NOTE:** Many standard bags with rings may be used in these vessels. Refer to Pentek Filtration's bag filter specifications sheet for 1 to 200 micron quick-install bags.

# ST Series Stainless Steel Filter Housings

- Heavy duty units for smaller filtration systems and point-of-use applications.
- Brushed 304 Stainless Steel sump with a cast brass/nickel plated head.
- Ideal for high pressure/hot water applications.
- Accepts complete range of standard double open end (DOE) cartridges.

ST Series stainless steel filter housings effectively provide heavy-duty filtration for smaller filtration systems and point-of-use applications. Supplying flow rates of up to 20 gpm (76 L/min), at a maximum water temperature of 300°F (149°C). ST Series are ideal for hot water and high-pressure applications not suited for plastic housings. The brushed 304 stainless steel sumps are available with either a pipe plug or pet-cock in the bottom for draining. Heads are manufactured from nickel-plated cast-brass.

ST Series housings are easy to install and maintain. They are compatible with a complete range of filter cartridges, adding to their versatility.

The Model ST-1 is a single cartridge filter ideal for filtering water at a flow rate not exceeding 10 U.S. GPM (depending on cartridge selection).

The Model ST-2 is identical to the ST-1, but requires two 9-3/4" (248mm) cartridges or one 19-1/2" (495mm) cartridge to provide higher capacity for longer operations of the filter between cartridge change-over.

The Model ST-3 is again identical to the ST-1 and ST-2 with even higher flow rate and greater dirt holding capacity than the ST-1 or ST-2. Requires three 9-3/4" (248mm) cartridges or one 29-1/4" (743mm) cartridge.



Item #	Description	No. 9-3/4" (248 mm) Cartridges	Filter Height in (mm)	Shipping Weight lbs (kg)	Flow Rate* GPM (LPM)	Max. Pressure w/pipe plug psi (bar)	Max. Pressure w/pet-cock psi (bar)
15601702	ST-1	1	12 7/8 (327)	7 (3.2)	10 (38)	250 (17.2)	250 (17.2)
15601802	ST-2	2	22 3/4 (578)	10-1/2 (4.8)	15 (57)	250 (17.2)	250 (17.2)
15601902	ST-3	3	32 3/8 (822)	13-1/2 (6.1)	20 (76)	250 (17.2)	250 (17.2)

\*When used with 20 micron (nominal) cartridge.  
 • Maximum cartridge diameter 3" (76 mm).  
 • Will not accept GAC, CC, CGAC, TSGAC, WS, PCF or PCC Series cartridges.

**Also Available:**

144128 Wall Bracket for ST-1, ST-2 and ST-3 156037 Mounting bracket for ST-1, ST-2 and ST-3



**Materials of Construction**

- **Housing** .....Brushed 304 Stainless Steel
- **Head** .....Brass/Nickel Plated
- **Maximum Temperature** ....300°F (149°C)
- **Pipe Size** .....3/4" NPT
- **Sealing Gaskets** .....Buna-N, Cellulose Fiber

**WARNING:** For drinking water applications, do not use with water that is microbiologically unsafe or of unknown quality without adequate disinfection before or after the system.

**CAUTION:** Protect against freezing to prevent cracking of the filter and water leakage.

**NOTE:** Not recommended for applications with TDS or chlorides >1000 and/or pH <5.0. Use of this product in these conditions will void the limited warranty. Consult factory for product modifications for these conditions.

# ST-BC Series Stainless Steel Filter Housings

- Heavy duty units for large scale commercial/industrial applications.
- Brushed 304 stainless steel construction with a gray-silver epoxy finish.
- Ideal for high-temperature applications.
- Accepts complete range of standard double open end (DOE) cartridges.

ST-BC Series stainless steel filter housings offer a variety of solutions for your large-scale, heavy-duty filtration needs. Simple to install and maintain, these housings are ideal for schools, restaurants, farms, institutions and industrial use. Holding from 4 to 20 cartridges, ST-BC Series housings provide flow rates from 28 - 125 gpm (106-473 L/min).

Housings are constructed of 304 stainless steel with a gray-silver epoxy finish. They include drains on both the “clean” and “dirty” sides of the sump.

ST-BC Series housings are compatible with a complete range of filter cartridges adding to their versatility.



Item #	Description	No.* Cartridges Dimensions	Filter Height in (mm)	Shipping Wgt. lbs (kg)	Flow Rate** GPM (LPM)	Max. Pressure psi (bar)	Pipe Size in (mm)
15602502	ST-BC-4	(4) 3" X 9-3/4" or 10" (76mm x 248mm or 254mm)	19 1/4 (489)	20 (9.1)	28 (106)	125 (8.62) to 300°F (149°C)	2 (50.8)
15602602	ST-BC-8	(8) 3" x 9-3/4" or 10" (76mm x 248mm or 254mm)	29 (737)	30 (13.6)	56 (212)	125 (8.62) to 300°F (149°C)	2 (50.8)
15602702	ST-BC-12	(12) 3" x 9-3/4" or 10" (76mm x 248mm or 254mm)	39 3/4 (1010)	40 (18.2)	84 (318)	125 (8.62) to 300°F (149°C)	2 (50.8)
15602802	ST-BC-16	(16) 3" x 9-3/4" or 10" (76mm x 248mm or 254mm)	49 3/4 (1264)	50 (22.7)	110 (416)	125 (8.62) to 300°F (149°C)	2 (50.8)
15603202	ST-BC-20	(20) 2 1/2" x 9-3/4" or 10" (64mm x 248mm or 254mm)	49 3/4 (1264)	50 (22.7)	125 (473)	125 (8.62) to 300°F (149°C)	2 (50.8)

Note: Will not accept model GAC, CC, CGAC, TSGAC, WS, PCF or PCC series cartridges.

\*Number of cartridges refers to the number of 9-3/4" (248 mm) or 10" (254 mm) cartridges which are configured around the housing times the number of cartridges that may be stacked. Example 4 x 2 means that 9-3/4" (248 mm) cartridges are configured four around and two high.

\*\*Above rated capacity based on sediment removal with a 25 micron filter cartridge and 1 PSIG initial clean pressure drop.

## Materials of Construction

- **Housing** .....Brushed 304 Stainless Steel
- **Finish** .....Epoxy
- **Maximum Temperature** ....300°F (149°C)
- **Maximum Pressure** ....125 psi (8.6 bar)
- **Pipe Size** .....2" (50.8 mm)
- **Sealing Gasket** .....Buna-N

**NOTE:** Maximum cartridge diameter 3" (76 mm).

**WARNING:** If pressure exceeds 125 psi (8.62 bar) at any time, a pressure regulator must be used. Do not use water that is microbiologically unsafe or of unknown quality without adequate disinfection before or after the system.

**CAUTION:** Protect against freezing to prevent cracking of the filter and water leakage.

**NOTE:** Not recommended for applications with TDS or chlorides >1000 and/or pH <5.0. Use of this product in these conditions will void the limited warranty. Consult factory for product modifications for these conditions.

# MPST-1 Multi-Purpose Stainless Steel Filter Housing

- Unique design accepts either a 4 1/2-inch x 20-inch DOE cartridge or a PENTEK Model 420 bag filter (Conversion Kit #243111).
- 304 stainless steel construction with epoxy finish.
- Equipped with several ports for differential pressure gauges.
- Heavy-duty design for numerous commercial and industrial applications.
- Ideal for high temperature or high pressure applications.

The PENTEK MPST-1 Multi-Purpose Stainless Steel Filter Housing is designed to accept either a 4 1/2-inch x 20-inch DOE cartridge or a PENTEK 420 style bag filter. The housing comes standard as a cartridge filter housing but the optional bag filter kit converts it to a bag filter housing in seconds.

Simple to install, maintain, and convert from cartridge to bag filter and back, this housing is ideal for schools, restaurants, farms, institutions and numerous industrial applications.

The MPST-1 housing is constructed of 304 stainless steel and powder coated with two-part epoxy with flow rates up to 50 GPM and maximum temperature ratings at 250°F, making it ideal for hot water and high pressure applications. An adjustable stand is included which adds to its versatility.

It is supplied with two-inch inlet and outlet ports and a threaded drain port for easy servicing. It is also equipped with several pressure differential gauge ports to aid in cartridge or bag filter replacement.



**MPST-1**

Item #	Maximum Flow Rate	Dimensions (Height x O.A. Dia*)	Pipe Size (NPT)	Maximum Temperature	Maximum Pressure
156237	50 GPM (189 L/min)	29" x 6-3/8" (737 mm x 162 mm)	2" (50.8 mm)	250°F (121°C)	150 psi (10.34 bar)

*Note: Will not accept model GAC 20BB, BBF1-20BB, WS-20BB or CRFC-20BB Cartridges.*

*\*Height does not include stand*

## Materials of Construction

- **Housing**.....304 Stainless Steel
- **Finish** .....Epoxy
- **Sealing Gasket** .....Buna-N

**NOTE:** Maximum cartridge diameter 4 3/4-inches (12 mm)

**WARNING:** If pressure exceeds 150 psi (10.34 bar) at any time, a pressure regulator must be used. Do not use water that is microbiologically unsafe or of unknown quality without adequate disinfection before or after the system.

**CAUTION:** Protect against freezing to prevent cracking of the filter and water leakage.

**NOTE:** Not recommended for applications with TDS or chlorides >1000 ppm and/or pH <5.0. Use of this product in these conditions will void the limited warranty. Consult factory for product modifications for these conditions.



# BFS/BBFS Series Basic Filtration Systems

- Multi-housing systems include wall-mounting bracket and hardware.
- Available with low-profile Slim Line® or large capacity Big Blue® housings.
- All systems are shipped completely pre-assembled.

BFS and BBFS Basic Filtration Systems consist of either two or three filter housings, which are mounted in series, a wall-mounting bracket and hardware.

The BFS-201 consist of a series of 3/8" NPT low-profile Slim Line® housings in series for installations where space is limited. The BBFS systems consist of a series of large-capacity 1" NPT #20 Big Blue® housings allowing for greater cartridge capacities and higher flow rates. All systems are equipped with a pressure relief button to relieve housing pressure during cartridge changes, and are shipped completely pre-assembled.

All of the housings are manufactured of a durable polypropylene, have excellent chemical resistance and are ideal for many residential, commercial and industrial applications.

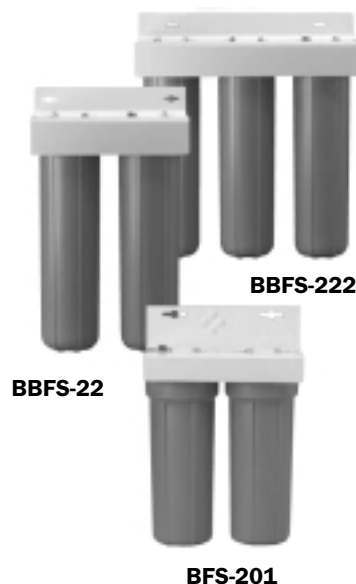

Item #	Description	Maximum Dimensions	Maximum Pressure
160166	BBFS-22	15-1/4" x 8-1/2" x 26-1/2" (388mm x 216mm x 673mm)	90 psi (6.2 bar)
160168	BBFS-222	23-1/4" x 8-1/2" x 26-1/2" (591mm x 216mm x 673mm)	90 psi (6.2 bar)
160196	BFS-201	10-1/2" x 5-1/4" x 14" (267mm x 133mm x 356mm)	125 psi (8.6 bar)

## Materials of Construction

- **Cap** ..... Polypropylene
- **Housing** ..... Polypropylene
- **Bracket** ..... Powder Coated Carbon Steel
- **O-Rings** ..... Buna-N
- **Maximum Temperature** ..... 100°F (37.8°C)

**NOTE:** 20" (508 mm) Big Blue® sumps are interchangeable with 10" (254 mm) Big Blue® sumps.

**NOTE:** Big Blue® is a registered trademark of Pentek Filtration.

**WARNING:** For drinking water applications, do not use with water that is microbiologically unsafe or of unknown quality without adequate disinfection before or after the system.

**CAUTION:** Protect against freezing to prevent cracking of the filter and water leakage.

# UMS-4 BB Housing Skid System

- Can be installed in series, parallel or combination of both.
- Manufactured from pultruded fiberglass for strength and fire resistance.
- Holds 4 Big Blue® filter housings or bag vessel assemblies.

The pultruded fiberglass is compatible with a wide range of organic and inorganic substances, but the UMS-4 is not compatible with all plating solutions. Assembly hardware is manufactured from 304 stainless steel for greater chemical resistance.

This system is capable of holding up to four Big Blue® filter housings or bag vessel assemblies. The housings can be assembled in series, parallel or a combination of both series and parallel to accommodate your filtration requirements.

## Item #160210

Dimensions H x W x D: 45-5/8" x 34-3/4" x 18"  
(1,159mm x 883mm x 457mm)



## The UMS-4 can be installed in the following combinations:

*Note: Sumps / Housings sold separately.*

### SERIES

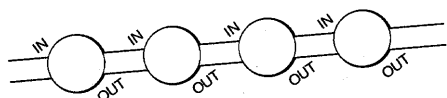

### PARALLEL

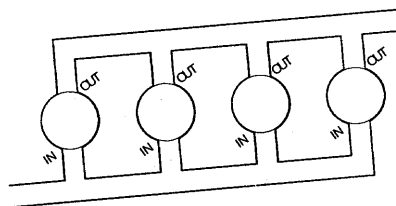

### COMBINATION - SERIES TO PARALLEL

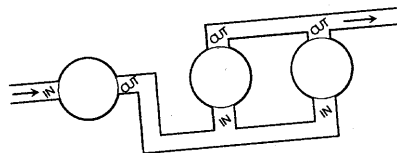

### COMBINATION - PARALLEL TO SERIES

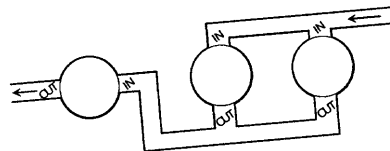

## Possible Flow Rates

- Parallel arrangement: up to 200 gpm (757 lpm) for filter bags  
up to 100 gpm (378.5 lpm) for filter cartridges
- Series arrangement: up to 50 gpm (189 lpm) for filter bags  
up to 25 gpm (94.6 lpm) for filter cartridges

# Chemical Compatibility Chart

Chemical	Temperature (°F)**	% Concentration**	Temperature (°F)**	Polypropylene TF	SAN	Nylon GF	Delrin	Buna-N	Silicone	Viton E-60	300 Series Stainless
Acetic Acid	125	50	A	A	D	A	D	C	--	C	--
Acetone	125	100	A	D	B	D	B	D	B	D	A
Ammonium Compounds	125	100*	A	A	A*	A	B	A	B	A	C
Ammonium Hydroxide	125	10	A	A	A	A	D	A	--	A	C
Beer	125	ANY	A	A	D	B	A	D	C	A	A
Benzene	72	100	B	D	A	D	B	D	--	A	B
Calcium Compounds	125	ANY*	A	A	A	A	A	A	C	A	B/C
Calcium Hypochlorite	68	20	A	--	D	--	D	B	C	A	D
Citric Acid	125	10	A	A	C	B	A	D	C	A	--
Cottonseed Oil	125	--	A	A	A	B	A	A	--	A	B
Detergents	125	2	A	A	A	A	A	A	--	A	--
Ethyl Alcohol	125	96	A	B	A	B	A	A	B	A	--
Freon	68	25	B	<sup>12</sup> / <sub>22</sub>	A	<sup>12</sup> / <sub>22</sub>	D	<sup>12-113</sup> / <sub>TF</sub>	D	<sup>12</sup>	<sup>II</sup> / <sub>ONLY</sub>
Fruit Juices	125	--	A	A	A	A	A	A	--	A	A
Gasoline	125	100	C	A	A	D	B	A	D	A	A
Glucose	125	20	A	A	A	A	A	A	B	A	A
Glycerin	125	100	A	A	A	B	A	A	B	A	A
Glycol	125	--	A	D	--	D	A	A	--	A	--
Hexane	125	100	C	--	A	D	D	A	B	A	A
Hydrochloric Acid	125	20	A	A	D	B	D	C	--	A	--
Hydrofluoric Acid	68	40	A	--	D	A	D	D	--	A	--
Hydrogen Peroxide	68	30	A	--	D	--	-D	D	--	A	--
Inks	125	--	A	B	A	B	A	A	--	A	A
Ketones	68	--	D	D	B	--	C	D	--	D	A
Lubricating Oils	125	100	C	A	A	B	A	A	C	A	A
Mercury	125	100	A	--	A	--	A	A	--	A	A
Methyl Alcohol	125	100	A	D	A	D	A	B	--	C	--
Mineral Oil	100	100	B	A	A	A	A	A	--	A	A
Naphthalene	125	100	A	B	A	C	D	B	D	A	A
Nitric Acid	68	10	A	B	D	C	D	D	--	A	A
Olive Oil	125	100	A	A	A	A	A	A	C	A	A
Plating Solutions	125	--	A*	--	A/D*	--		A*	D	A	--
Sodium Compounds	125	ANY	A	A	A/C*	C	--	A	C	A	B
Sodium Hypochlorite	100	5	A	A	A	B	A	A	C	A	B
Sugar & Syrups	125	--	A	--	A	B	A	A	A	A	A
Sulfuric Acid	68	25	A	A	D	B	D	C	--	A	--
Toluene	100	--	D	D	A	D	D	D	D	C	A
Water (hot)	200	100	--	--	A	--	--	C	A	B	A
DI Water	125	100	B	A	A	A	A	A	A	A	--
Sea Water	125	100	A	B	A	A	C	A	--	A	--
Whiskey/Wines	125	--	A	A	A	A	A	A	--	A	A
Xylene	100	100	C	D	A	D	D	D	D	A	A

A = Negligible Effect  
 B = Limited Absorption Attack  
 C = Extensive Absorption and/or Rapid Permeation  
 D = Extensive Attack

\* Consult Factory for Specific Compound  
 \*\* Maximum  
 TF = Talc Filled  
 GF - Glass Filled

**NOTICE:** We cannot anticipate all conditions under which this information and our products, or the products of other manufacturers in combination with our products, may be used. We accept no responsibility for results obtained by the application of this information or the safety and suitability of our products, either alone or in combination. Users are advised to make their own tests to determine the safety and suitability of each product combination for their own purposes and applications. Unless otherwise agreed in writing, or previously tested by Pentek Filtration on specific applications, we sell the product without warranty against chemicals listed above. Buyers and users assume all responsibility for liability performance or damage.

# Pentek® Filter Housings Pressure Drop

PRESSURE/FLOW	NET PRESSURE DROP - psi (bar) @ FLOW RATE - gpm (lpm)														
	1 (4)	3 (11)	5 (19)	8 (30)	10 (38)	15 (57)	20 (76)	25 (95)	30 (114)	35 (132)	40 (151)	50 (189)	60 (227)	70 (265)	80 (303)
1/4" Slim Line™	<1 (.1)	2 (.1)	4 (.3)	10 (.7)	15 (1.0)										
3/8" Slim Line™	<1 (.1)	<1 (.1)	2 (.1)	5 (.4)	7 (.5)										
1/2" Slim Line™	<1 (.1)	<1 (.1)	2 (.1)	5 (.4)	7 (.5)										
3/4" Standard	<1 (.1)	<1 (.1)	<1 (.1)	<1 (.1)	1 (.1)	2 (.1)	3 (.2)								
3/4" V-I-H	<1 (.1)	1 (.1)	2 (.1)	4 (.3)	7 (.5)	16 (1.1)									
Big Blue® HFPP 3/4"	<1 (.1)	<1 (.1)	<1 (.1)	<1 (.1)	1 (.1)	2 (.1)	3 (.2)								
Big Blue® HFPP 1"	<1 (.1)	<1 (.1)	<1 (.1)	<1 (.1)	1 (.1)	1 (.1)	2 (.1)	3 (.2)	4 (.3)	5 (.4)	7 (.5)	11 (.8)	16 (1.1)		
Big Blue® HFPP 1-1/2"	<1 (.1)	<1 (.1)	<1 (.1)	<1 (.1)	<1 (.1)	1 (.1)	1 (.1)	2 (.1)	2 (.1)	3 (.2)	4 (.3)	7 (.5)	10 (.7)	13 (.9)	

**CAUTION:** Do not use with water that is microbiologically unsafe or of unknown quality without adequate disinfection before or after the unit.

**NOTE:** The pressure drop values listed for flow rates higher than 10 gpm were extrapolated from curves, except in the case of the Big Blue® housings. All tests were performed on empty housings (no cartridges.)

# Pentek® Mounting Brackets



## **For Big Blue® Housings**

This bracket is made for the 10" and 20" Big Blue® housings only.

- 150061 WB-SS Kit, Bracket and Screws, Powder-Coated Carbon Steel
- 144092 WB-SS, Bracket Only, Stainless Steel



## **Standard Housing Brackets**

### **For Mounting Caps with Bosses**

The MC-1 bracket is made for the 3/4" (19mm) housings with bosses only. It is constructed of zinc-plated steel.

- 150578 MC-1 Kit, Bracket and Screws, 3/4" CAPS only
- 144090 MC-1 Bracket Only, 3/4" CAPS only



## **For 3/4" Housings**

The UB-1 bracket is made for the 3/4" (19mm) inlet/outlet housings only. It is constructed of zinc-plated steel.

- 151011 UB-1 Kit, Bracket and Screws, 3/4" CAPS only
- 14401200 UB-1 Bracket Only, 3/4" CAPS only



## **Slim Line™ Mounting Brackets**

### **For 1/4", 3/8" and 1/2" Housings**

For Slim Line™ Housings with 1/4", 3/8" and 1/2" inlet/outlet. It is constructed of zinc-plated steel. The kit includes bracket and screws.

- 26023 Kit, Bracket and Screws, 1/4", 3/8" and 1/2" Slim Line™
- 14402500 Bracket Only, 1/4", 3/8" and 1/2" Slim Line™



## **CCF & RO System Brackets**

- 14414202 Slim Line™ Bracket, Two-Housing, CCF & RO
- 14416902 Slim Line™ Bracket, Three-Housing, CCF & RO

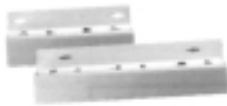

## **Big Blue® System Bracket**

For Big Blue® housings with 3/4", 1" and 1-1/2" inlet/outlet. 2 or 3 housing brackets available. Made of powder-coated carbon steel.

- 144258 Big Blue® Bracket, Two-Housing
- 144259 Big Blue® Bracket, Three-Housing



## **150370 Bag Housing Stand**

For Big Blue® bag housings and Big Blue® cartridge housings. Made of SuperFlexon®

# Pentek® Accessories



### Cartridge Couplers

155003 Standard coupler available for standard double open end (DOE) cartridges  
Material: polypropylene



### Sump Extension

157209 Used for all natural polypropylene housings  
Material: polypropylene



### Big Blue® Coupler

144229 Available for Big Blue® (4-1/2" diameter) DOE cartridges  
Material: Polypropylene



### Cap Plug Kit

144457 For vents or gauges  
Includes plug and O-ring



### Spanner Wrenches

Used to loosen sump when changing cartridges.

150539 Wrench, Sump, SW-1A, Slim Line & 3G Housings  
150295 Wrench, Sump, SW-2, Standard 3/4" Housings  
150296 Wrench, Sump, SW-3, #10BB Housings  
144368 Wrench, Sump, SW-4, #20BB Housings  
144880 Wrench, Sump, Big Clear

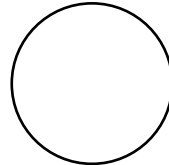

### O-Rings

#### Buna-N FDA Grade

151121 237 for #5 & #10 Slim Line™ Housings  
151120 241 for #10, #12 & #20 Housings  
151122 Big Blue® O-Ring

#### Silicone FDA Grade

158096 237 for #5 & #10 Slim Line™ Housings  
151118 241 for #10, #12 and #20 Housings

#### Viton

157193 012 Kit for Vent Plugs  
158095 237 for #5 & #10 Slim Line™ Housings  
151117 241 for #10, #12 and #20 Housings

## Differential Pressure Gauges

These gauges can be read from both sides. They tell the user when to change the cartridge while the filter is in operation. They are easily mounted directly to MM (Meter Mount) caps with screws provided. Both are constructed of glass-filled nylon, Buna-N O-rings, 304 SS spring. 143549 contains a ceramic magnet.

### Color Change Differential Pressure Gauge

Green and red color indicate when cartridge should be changed.  
Green (clean) 0-7 psid; Red (change) 7-10 psid.  
Item # 143550

143550



### Needle Differential Pressure Gauge

Needle points to international standard colors to determine when cartridge needs to be changed. Green (clean) 0-6 psid; Yellow (change) 6-9 psid; Red (dirty) 9-12 psid.  
Item # 143549

143549



# Pentek® Sumps & Caps

Item #	Description	Item #	Description
<b>Filter Housing Caps</b>		<b>Filter Housing Sumps</b>	
154049	1/4" Black Cap w/o pr for Slim Line® & #5 Blue Housings	153014	#5 Slim Line® Blue Sump
154053	1/4" Blue Cap w/o pr for Slim Line® & #5 Clear Housings	153056	#5 Slim Line® Clear Sump
154062	1/4" White Cap w/o pr for Slim Line® Housings	153049	#10 Slim Line® White Sump
154108	3/8" Black Cap w/pr for Slim Line® & #5 Blue Housings	153062	#10 Slim Line® Black Sump
154006	3/8" Black Cap w/o pr for Slim Line® & #5 Blue Housings	153017	#10 Slim Line® Blue Sump
154111	3/8" Blue Cap w/pr for Slim Line® & #5 Clear Housings	153018	#10 Slim Line® Clear Sump
154010	3/8" Blue Cap w/o pr for Slim Line® & #5 Clear Housings	153093	#10 Slim Line® Black Nylon Sump
154171	1/2" Black Cap w/pr for Slim Line® & #5 Blue Housings	153063	#10 Std Black Nylon Sump
154083	1/2" Black Cap w/o pr for Slim Line® & #5 Blue Housings	153005	#10 Std Red High Temp Sump
154175	1/2" Blue Cap w/pr for Slim Line® & #5 Clear Housings	153001	#10 Blue Sump
154503	1/2" Black Nylon Cap w/o pr for Slim Line® Black Nylon Housing	153128	#10 Clear Sump
154101	3/4" Black Cap w/pr for #10 & #20 Blue Housings	153013	#20 Blue Sump
154001	3/4" Black Cap w/o pr for #10 & #20 Blue Housings	153058	#20 Slim Line® Blue Sump
154102	3/4" Blue Cap w/pr for #10 Clear Housings	153092	#20 Slim Line® Black Nylon Sump
154115	3/4" Black Mounting Bracket Cap w/pr for #10 & #20 Blue Housings	153064	#20 Std Black Nylon Sump
154017	3/4" Black Mounting Bracket Cap w/o pr for #10 & #20 Blue Housings	153029	#10 Big Blue® Sump
154116	3/4" Blue Mounting Bracket Cap w/pr for #10 Clear Housings	153114	#10 Big Blue® Sump - White
154018	3/4" Blue Mounting Bracket Cap w/o pr for #10 Clear Housings	153208	#10 Big Clear Sump
154134	3/4" Black VIH Cap w/pr for #10 & #20 VIH Blue Housings	153070	#20 Big Blue® Sump
154138	3/4" Blue VIH Cap w/pr for #10 Clear VIH housing	153166	#20 Big Clear Sump
154061	3/4" Black Nylon Cap w/o pr for #10 & #20 housings	153080	#20 Big Blue® Sump - White
154003	3/4" Red High Temperature Cap w/o pr	153042	#10 All Natural Std. Sump - No Drain Plug (style 2)
154195	3/4" Black HFPP Cap w/pr for Big Blue® Housings	153101	#10 All Natural Std. Sump w/Drain Plug
154166	1" Black HFPP Cap w/pr for Big Blue® Housings	153046	#12 All Natural Sump for 222 - No Drain Plug
154077	1" Black HFPP Cap w/o pr for Big Blue® Housings	153106	#12 All Natural Sump for 222 - With Drain Plug
154291	1" Black Cap for Big Clear Housings	153040	#20 All Natural Std. Sump - No Drain Plug
154167	1-1/2" Black HFPP Cap w/pr for Big Blue® Housings	153102	#20 All Natural Std. Sump - With Drain Plug
154078	1-1/2" Black HFPP Cap w/o pr for Big Blue® Housings	153055	#20 Ext All Natural Sump for 222 - No Drain Plug
154025	#10, #12, & #20 All Natural Cap, Std., No Plugs	153107	#20 Ext All Natural Sump for 222 - With Drain Plug
154135	#10, #12, & #20 All Natural Cap, Std., w/Two Vent Plugs	<b>3G Filter Housing Sumps</b>	
154351	#10, #12, & #20 All Natural 222 Cap, Std., No Plugs	153202	3G #10 SL Blue Sump
154136	#10, #12, & #20 All Natural 222 Cap, Std., w/Two Vent Plugs	153203	3G #10 SL Clear Sump
154082	Countertop White Cap - 1/4" Inlet/Outlet (for #5 and #10 Units)	153197	3G #10 ST Blue Sump
<b>3G Filter Housing Caps</b>		153194	3G #10 ST Clear Sump
154638	3G 3/4" Black Mounting Bracket Cap w/pr	153200	3G #20 ST Blue Sump
154584	3G 3/4" Black Mounting Bracket Cap w/o pr	153195	3G #20 ST Clear Sump
154646	3G 3/4" Black Integral Bracket Cap w/pr		
154600	3G 3/4" Black Integral Bracket Cap w/o pr		
154622	3G 3/4" Black Integral Bracket Cap, Meter Mount w/pr		
154639	3G 3/4" Blue Mounting Bracket Cap w/pr		
154585	3G 3/4" Blue Mounting Bracket Cap w/o pr		
154647	3G 3/4" Blue Integral Bracket Cap w/pr		
154788	3G 3/8" Black Mounting Bracket Cap w/pr		
154790	3G 3/8" Blue Mounting Bracket Cap w/pr		
154737	3G 3/8" Blue Mounting Bracket Cap w/o pr		
154804	3G 3/8" Black Integral Bracket Cap w/pr		
154806	3G 3/8" Blue Integral Bracket Cap w/pr		

# C Series Dual Purpose Powdered-Activated Carbon Cartridges

- Economically priced.
- Provides sediment filtration and bad taste & odor and chlorine taste & odor reduction.\*
- High dirt-holding capacity.
- Available in 4 sizes and two micron ratings.
- Recommended for chlorinated water supplies.

C Series cartridges offer an economical solution for all of your general-purpose water filtration needs. Constructed of a carbon impregnated cellulose media, these dual-purpose cartridges filter out fine sediment particles and reduce unwanted taste, odor and chlorine taste and odor from your tap water.\* A polyester reinforcement backing and external netting provide additional strength and dirt-loading capacity.

C Series cartridges are available in three different sizes and both the C-1 and C-2 are nominally rated at 5-microns

These dual-purpose cartridges are well suited for a wide range of residential applications, and make excellent polishing filters when used in process or closed-loop streams.

\* Based on manufacturer's internal testing.





This C1 is Tested and certified by NSF International under ANSI/NSF Standard 42 for material requirements only.

COMPONENT

Item #	Description	Maximum Dimensions	Micron Rating (Nominal)*	Initial ΔP (psi) @ Flow Rate (gpm)	Chlorine Reduction @ Flow Rate (gpm)
15500243	C1	2-1/2" x 9-3/4" (64mm x 248mm)	5	4 psi @ 5 gpm (0.3 bar @ 18.9 lpm)	>2,500 gallons @ 1 gpm* (>9,500 liters @ 3.8 lpm)
15502243	C2	2-1/2" x 4-7/8" (64mm x 124mm)	5	2.0 psi @ 2 gpm (0.1 bar @ 7.6 lpm)	>1,250 gallons @ 0.5 gpm* (>4,700 liters @ 1.9 lpm)
15559743	C1-20	2-1/2" x 20" (64 mm x 508mm)	5	1.0 psi @ 5 gpm (0.1 bar @ 19 lpm)	>5,000 gallons @ 2 gpm* (>18,900 liters @ 7.6 lpm)

## Materials of Construction

- **Filter Media** .....PAC Impregnated Cellulose
- **End Caps**.....Vinyl Plastisol (C1 & C2)
- **Netting**.....Polyethylene
- **Reinforcement Backing** ..Cellulose Polyester (C1 & C2)
- **Core** .....Polypropylene
- **Temperature Rating** .....40°F to 125°F (4.4°C to 52°C)  
(C1, C2, C1-20)

**WARNING:** For drinking water applications, do not use with water that is microbiologically unsafe or of unknown quality without adequate disinfection before or after the system.

**NOTE:** Some harmless bacteria will attack cellulose media cartridges. If your cartridge seems to disintegrate, or has a musty or moldy odor, switch to a synthetic media cartridge or consult the manufacturer.

\***NOTE:** Estimated capacity tested at given flow rate using 2 ppm free available chlorine at continuous flow to 0.5 ppm breakthrough.

**NOTE:** Increased flow rates may result in less effective chlorine reduction.

\*Based on manufacturer's internal testing.



# FloPlus™ Series Modified Molded Carbon Block Cartridges

- Nominal 0.5-micron rating.
- 99.95% reduction of Cryptosporidium and Giardia cysts.
- Premium dirt-holding capacity.
- Outstanding chlorine taste and odor reduction.
- True depth filtration which offers greatest life of any cyst-capable carbon cartridge.

FloPlus™ cartridges utilize a revolutionary new technology that significantly enhances the traditional Fibredyne product, making it possible to obtain cyst reduction in a cartridge that functions like a nominal 10-micron cartridge.

This product boasts extremely low pressure drops and high flow rates – comparable to 10-micron (very open) carbon cartridges. Its efficiency is so high that a 0.5 micron rating is possible, which means that cysts and very small particles can be removed to create cleaner, safer water.

This product is ideal for applications where pressure drop and low flow have been chronic problems in the past, as well as whole house water treatment with the addition of cyst reduction. However, it will address the needs of any end user looking for a product that offers high flow, low pressure drop, infrequent cartridge changes and cyst-free water.

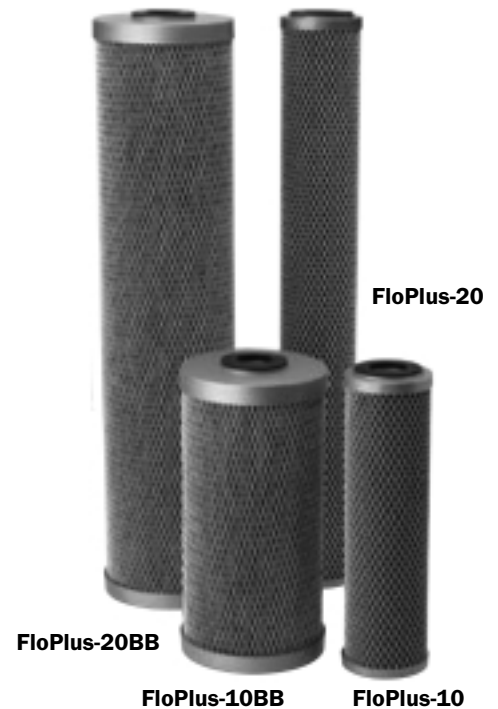

The FPS-10 with the FloPlus 10, FPS-20 with the FloPlus 20, FPS-10BB and the FPS-20BB with the FloPlus 20BB are Tested and Certified by NSF International to NSF/ANSI Standard 53 for the reduction of Cysts.

COMPONENT

Item #	Description	Maximum Dimensions	Micron Rating (Nominal)*	Initial ΔP (psi) @ Flow Rate (gpm)	Chlorine Reduction @ Flow Rate (gpm)
45590343	FloPlus-10	2-7/8" x 9-3/4" (73mm x 248mm)	0.5	2.0 psi @ 1 gpm (0.1 bar @ 3.8 lpm)	>10,000 gallons @ 1 gpm (>37,800 liters @ 3.8 lpm)
45590443	FloPlus-20	2-7/8" x 20" (73mm x 508mm)	0.5	2.0 psi @ 2 gpm (0.1 bar @ 7.6 lpm)	>20,000 gallons @ 2 gpm (>75,700 liters @ 7.6 lpm)
40390543	FloPlus-10BB	4-5/8" x 9-3/4" (118 mm x 248mm)	0.5	4.0 psi @ 2 gpm (0.3 bar @ 7.6 lpm)	>25,000 gallons @ 2 gpm (>94,500 liters @ 7.6 lpm)
40390643	FloPlus-20BB	4-5/8" x 20" (118mm x 508mm)	0.5	4.0 psi @ 4 gpm (0.3 bar @ 15.2 lpm)	>50,000 gallons @ 4 gpm (>189,000 liters @ 15.2 lpm)

## Materials of Construction

- **Filter Media** .....Bonded PAC
- **End Caps** .....Polypropylene
- **Netting** .....Polyethylene
- **Gaskets** .....Santoprene™
- **Temperature Rating** .....40°F to 180°F (4.4°C to 82.2°C)

**WARNING:** For drinking water applications, do not use with water that is microbiologically unsafe or of unknown quality without adequate disinfection before or after the system.

**NOTE:** Performance capacity depends on system design, flow rate and certain other application conditions. Certain states require system registration or certification for health-related reduction claims.

**NOTE:** A drinking water cartridge may contain carbon fines (very fine black powder). After installation and before using the water, follow the instructions for flushing the cartridge to remove fines.

**NOTE:** It is recommended that you run the tap for 20 seconds prior to using the water for drinking or cooking purposes.

# NCP Series Non-Cellulose Carbon-Impregnated Pleated Cartridges

- Non-cellulose media resists bacterial attack.
- Provides sediment filtration and chlorine taste & odor reduction.
- Pleated for maximum dirt-loading capacity.
- Nominal 10-micron rating.

NCP Series cartridges are constructed from a carbon-impregnated non-cellulose media. They offer sediment-filtration, as well as taste, odor and chlorine taste & odor reduction in one cartridge. Unlike cellulose cartridges, NCP Series cartridges are resistant to both bacterial attack allowing them to be used for municipal and non-chlorinated water applications.

Pleats provide additional surface area for high dirt-loading capacity, while maintaining minimal pressure drop. This combination of a pleated polyester media and carbon filtration produces an outstanding filter cartridge with extended service life.

NCP Series cartridges are excellent polishing filters, closed loop streams and are ideal for post reverse osmosis and well water applications.



Item #	Description	Maximum Dimensions	Micron Rating (Nominal)*	Initial ΔP (psi) @ Flow Rate (gpm)	Chlorine Reduction @ Flow Rate (gpm)*
15536743	NCP-10	2-1/2" x 9-3/4" (764mm x 248mm)	10	2 psi @ 3 gpm (0.1 bar @ 11 lpm)	225 gallons @ 1 gpm (850 liters @ 3.8 lpm)
15539843	NCP-BB	4-1/2" x 9-3/4" (114mm x 248mm)	10	2 psi @ 8 gpm (0.1 bar @ 30 lpm)	500 gallons @ 2 gpm (1,890 liters @ 7.6 lpm)
15539743	NCP-20	2-1/2" x 20" (64mm x 508mm)	10	2 psi @ 5 gpm (0.1 bar @ 19 lpm)	450 gallons @ 2 gpm (1,700 liters @ 7.6 lpm)
15538243	NCP-20BB	4-1/2" x 20" (114mm x 508mm)	10	1 psi @ 10 gpm (<0.1 bar @ 38 lpm)	1,000 gallons @ 4 gpm (3,780 liters @ 15 lpm)

\*Filtration efficiency and chlorine taste and odor reduction efficiency are reduced at higher flow rates. Chlorine taste and odor reduction based on greater than 50% reduction using 2ppm free chlorine feed concentration at 68°F (20°C) at continuous flow.

## Materials of Construction

- **Filter Media** .....Pleated Carbon-Impregnated Polyester
- **End Caps** .....Vinyl Plastisol
- **Core** .....Polypropylene
- **Netting** .....Polyethylene
- **Temperature Rating** ..40°F to 125°F (4.4°C to 52°C)

**WARNING:** Do not use with water that is microbiologically unsafe or of unknown quality without adequate disinfection before or after the system.

# CFB Series Modified Molded Block Cartridges

- Nominal 10-micron rating.\*
- Excellent dirt-holding capacity.\*
- High chlorine taste & odor and bad taste & odor reduction.\*
- Economic choice for high sediment applications leading to premature plugging.

CFB Series cartridges provide the effective chlorine taste & odor reduction found in traditional carbon block media while offering excellent sediment reduction capabilities.\*

CFB Series products are a modified molded block created by use of our proprietary Fibredyne technology. This technology creates a unique filter media by attaching powdered activated carbon onto a cellulose-free synthetic fiber matrix. The result is a single cartridge that combines the benefits of both a sediment filter and a carbon block into a single cartridge. Fibredyne's carbon block technology also offers up to two times the chlorine taste & odor reduction and dirt-holding capacity of traditional blocks.\* In addition, this technology will not release fines into the effluent stream due to a unique post-filtration layer that is fused to the carbon/fiber media blend.

CFB Series cartridges are manufactured entirely from FDA-compliant materials, making them an ideal choice for a wide range of residential, food service, commercial and industrial applications.

\* Based on manufacturer's internal testing.



COMPONENT

Tested and Certified by NSF International to NSF/ANSI Standard 42 for material requirements only.

Item #	Description	Maximum Dimensions	Micron Rating (Nominal)	Initial ΔP (psi) @ Flow Rate (gpm)	Chlorine Taste & Odor Reduction @ Flow Rate (gpm)
25567143	CFB-10	2-7/8" x 9-3/4" (73mm x 248mm)	10	3.0 psi @ 1 gpm (0.7 bar @ 3.8 Lpm)	>5,000 gallons @ 1 gpm (>18,900 L @ 3.8 Lpm)
25567243	CFB-20	2-7/8" x 20" (73mm x 508mm)	10	3.0 psi @ 2 gpm (0.7 bar @ 7.6 Lpm)	>10,000 gallons @ 2 gpm (>37,800 L @ 7.6 Lpm)
25567343	CFB-30	2-7/8" x 30" (73mm x 762mm)	10	3.0 psi @ 2 gpm (0.7 bar @ 11.4 Lpm)	>15,000 gallons @ 3 gpm (>56,700 L @ 11.4 Lpm)

## Materials of Construction

- **Filter Media** .....Bonded PAC
- **End Caps** .....Polypropylene
- **Netting** .....Polyethylene
- **Gaskets** .....Santoprene™
- **Temperature Rating** .....40°F to 180°F (4.4°C - 82.2°C)

**WARNING:** Do not use with water that is microbiologically unsafe or of unknown quality without adequate disinfection before or after the unit.

**NOTE:** Performance capacity depends on system design, flow rate and certain other application conditions. Certain states require system registration or certification for health-related contaminant reduction claims.

**NOTE:** Cartridges will contain a very small amount of carbon fines (very fine black powder). After installation, a new cartridge should be flushed with sufficient water to remove all traces of fines prior to using the water.

**NOTE:** Micron ratings based on 85% or greater removal of given particle size. Estimated capacity using 2ppm free available chlorine at 0.5 ppm breakthrough.

# CFB-Plus Series Modified Molded Block Cartridges

- Nominal 10-micron rating.
- Premium dirt-holding capacity.\*
- Premium chlorine taste & odor and bad taste & odor reduction.\*

The CFB-Plus Series cartridges are an enhanced version of our CFB product. It offers the same benefits with even greater chlorine taste & odor reduction and the highest sediment reduction found in a carbon cartridge.\*

CFB-Plus Series products are modified molded blocks manufactured using our proprietary Fibredyne technology. This technology creates a unique filter media by attaching powdered activated carbon onto a cellulose-free synthetic fiber matrix. The result is a single cartridge that combines the benefits of both a sediment filter and a carbon block into a single cartridge.

Fibredyne's carbon block technology also offers up to two times the chlorine taste & odor reduction and dirt-holding capacity of traditional blocks.\* In addition, this technology will not release fines into the effluent stream due to a unique post-filtration layer that is fused to the carbon/fiber media blend.

CFB-Plus Series cartridges are manufactured entirely from FDA-compliant materials, making them an ideal choice for a wide range of residential, food service, commercial and industrial applications.

\* Based on manufacturer's internal testing.



Tested and Certified by NSF International to NSF/ANSI Standard 42 for material requirements only.

COMPONENT

Item #	Description	Maximum Dimensions	Micron Rating (Nominal)	Initial ΔP (psi) @ Flow Rate (gpm)	Chlorine Taste & Odor Reduction @ Flow Rate (gpm)
25567443	CFB-Plus10	2-7/8" x 9-3/4" (73mm x 248mm)	5-10	1.6 psi @ 1 gpm (0.7 bar @ 3.8 Lpm)	>10,000 gallons @ 1 gpm (>37,800 L @ 3.8 Lpm)
25567543	CFB-Plus20	2-7/8" x 20" (73mm x 508mm)	5-10	1.6 psi @ 2 gpm (0.7 bar @ 7.6 Lpm)	>20,000 gallons @ 2 gpm (>75,700 L @ 7.6 Lpm)
25567643	CFB-Plus30	2-7/8" x 30" (73mm x 762mm)	5-10	1.6 psi @ 3 gpm (0.7 bar @ 11.4 Lpm)	>30,000 gallons @ 3 gpm (>113,500 L @ 11.4 Lpm)
25567743	CFB-Plus10BB	4-5/8" x 9-3/4" (118mm x 248mm)	5-10	2.5 psi @ 2 gpm (0.2 bar @ 7.6 Lpm)	>25,000 gallons @ 2 gpm (>94,600 L @ 7.6 Lpm)
25567843	CFB-Plus20BB	4-5/8" x 20" (118mm x 508mm)	5-10	2.5 psi @ 4 gpm (0.2 bar @ 11.4 Lpm)	>50,000 gallons @ 4 gpm (>189,000 L @ 15.1 Lpm)

## Materials of Construction

- **Filter Media** .....Bonded PAC
- **End Caps** .....Polypropylene
- **Netting** .....Polyethylene
- **Gaskets** .....Santoprene™
- **Temperature Rating** .....40°F to 180°F (4.4°C - 82.2°C)

**WARNING:** Do not use with water that is microbiologically unsafe or of unknown quality without adequate disinfection before or after the unit.

**NOTE:** Performance capacity depends on system design, flow rate and certain other application conditions. Certain states require system registration or certification for health-related contaminant reduction claims.

**NOTE:** Cartridges will contain a very small amount of carbon fines (very fine black powder). After installation, a new cartridge should be flushed with sufficient water to remove all traces of fines prior to using the water.

**NOTE:** Micron ratings based on 85% or greater removal of given particle size. Estimated capacity using 2ppm free available chlorine at 0.5 ppm breakthrough.

# CFBC Series Modified Molded Block Cartridges

- Nominal 0.5-micron rating.\*
- 99.95% reduction of Cryptosporidium and Giardia Cysts.\*
- Premium dirt-holding capacity.\*
- High chlorine taste & odor and bad taste and odor reduction.\*

CFBC Series cartridges offer the effective chlorine taste and odor reduction found in traditional carbon block media while providing superior sediment reduction with resistance to premature plugging. They are highly effective at reducing chlorine taste & odor, bad taste and odor, as well as some organic chemicals.\*

CFBC Series products are modified molded blocks manufactured using our proprietary Fibredyne technology. This technology creates a unique filter media by attaching powdered activated carbon onto a cellulose-free synthetic fiber matrix. The result is a single cartridge that combines the benefits of both a sediment filter and a carbon block into a single cartridge.

Benefits of this technology include low pressure drop over the entire life of the cartridge and up to three times the chlorine taste & odor and dirt-holding capacity of traditional 0.5 micron carbon blocks.\* In addition, Fibredyne's technology will not release fines into the effluent stream due to a unique post-filtration layer that is fused to the carbon/fiber media blend.

CFBC Series cartridges are manufactured entirely from FDA-compliant materials, making them an ideal choice for a wide range of residential, food service, commercial and industrial applications.

\* Based on manufacturer's internal testing.



Tested and Certified by NSF International to NSF/ANSI Standard 42 for material requirements only.

COMPONENT

Item #	Description	Maximum Dimensions	Micron Rating (Nominal)	Initial ΔP (psi) @ Flow Rate (gpm)	Chlorine Taste & Odor Reduction @ Flow Rate (gpm)
25567943	CFBC-10	2-7/8" x 9-3/4" (73mm x 248mm)	0.5	10.7 psi @ 1 gpm (0.7 bar @ 3.8 Lpm)	>20,000 gallons @ 1 gpm (>75,700 L @ 3.8 Lpm)
25568043	CFBC-20	2-7/8" x 20" (73mm x 508mm)	0.5	10.7 psi @ 2 gpm (0.7 bar @ 7.6 Lpm)	>40,000 gallons @ 2 gpm (>75,700 L @ 7.6 Lpm)

## Materials of Construction

- **Filter Media** .....Bonded PAC
- **End Caps** .....Polypropylene
- **Netting** .....Polyethylene
- **Gaskets** .....Santoprene™
- **Temperature Rating** .....40°F to 180°F (4.4°C - 82.2°C)

**WARNING:** Do not use with water that is microbiologically unsafe or of unknown quality without adequate disinfection before or after the unit.  
**NOTE:** Performance capacity depends on system design, flow rate and certain other application conditions. Certain states require system registration or certification for health-related contaminant reduction claims.

**NOTE:** Cartridges will contain a very small amount of carbon fines (very fine black powder). After installation, a new cartridge should be flushed with sufficient water to remove all traces of fines prior to using the water.

**NOTE:** Micron ratings based on 85% or greater removal of given particle size. Estimated capacity using 2ppm free available chlorine at 0.5 ppm breakthrough.

# CFB-PB10 Lead Reduction Modified Molded Block Cartridges

- Nominal 0.5-micron rating.\*
- 99.95% reduction of Cryptosporidium and Giardia cysts.\*
- Lead reduction through 2000 gallons.\*
- Premium dirt-holding capacity.\*
- High chlorine taste & odor and bad taste and odor reduction.\*

The CFB-PB cartridge offers the benefits of effective chlorine taste & odor, cyst and lead reduction found in traditional carbon block media while offering premium sediment filtration.\*

The CFB-PB product is modified molded block manufactured using our proprietary Fibredyne technology. This technology creates a unique filter media by attaching powdered activated carbon and lead adsorbent material onto a cellulose-free synthetic fiber matrix. This results in higher reduction efficiencies that resist plugging, afford the longest life, and feature the lowest pressure drop over the effective life of the cartridge of any available 0.5 micron filter cartridge.\*

Fibredyne's carbon block technology also offers up to two times the chlorine taste & odor reduction and dirt-holding capacity of traditional blocks.\* In addition, this technology will not release fines into the effluent stream due to a unique post-filtration layer that is fused to the carbon/fiber media blend.

The CFB-PB cartridge is manufactured entirely from FDA-compliant materials, making it an ideal choice for a wide range of residential, food service, commercial and industrial applications.

\* Based on manufacturer's internal testing.



Tested and Certified by NSF International to NSF/ANSI Standard 42 for material requirements only.

COMPONENT

Item #	Description	Maximum Dimensions	Micron Rating (Nominal)	Initial ΔP (psi) @ Flow Rate (gpm)	Chlorine Taste & Odor Reduction @ Flow Rate (gpm)
25568143	CFB-PB10	2-7/8" x 9-3/4" (73mm x 248mm)	0.5	8.1 psi @ 1 gpm (0.6 bar @ 3.8 Lpm)	>5,000 gallons @ 1 gpm (>18,900 L @ 3.8 Lpm)

## Materials of Construction

- **Filter Media** .....Bonded PAC
- **End Caps** .....Polypropylene
- **Netting** .....Polyethylene
- **Gaskets** .....Santoprene™
- **Temperature Rating** .....40°F to 180°F (4.4°C to 82.2°C)

**WARNING:** Do not use with water that is microbiologically unsafe or of unknown quality without adequate disinfection before or after the unit.

**NOTE:** Performance capacity depends on system design, flow rate and certain other application conditions. Certain states require system registration or certification for health-related contaminant reduction claims.

**NOTE:** Cartridges will contain a very small amount of carbon fines (very fine black powder). After installation, a new cartridge should be flushed with sufficient water to remove all traces of fines prior to using the water.

**NOTE:** Micron ratings based on 85% or greater removal of given particle size. Estimated capacity using 2ppm free available chlorine at 0.5 ppm breakthrough.

# ELPC Series Electroplating Carbon Cartridges

- Cellulose-free construction.
- Resistant to chemical breakdown in both acidic and alkaline solutions up to 180°F (82°C).
- Will not contribute to plating porosity or brittleness.
- Integrated post-filtration layer to ensure that no carbon fines are bled into the plating bath.
- End cap gaskets are permanently molded on to the end caps to ease filter cartridge change-out (gaskets cannot fall off into the filter housing during installation or removal of filter).

The ELPC Series is a premium line of activated carbon filter cartridges specifically designed for electroplating solutions. They represent the best technology available in cartridge filtration for use in a wide range of electroplating applications.

The unique technology used to manufacture this product ensures that there is no bleeding of carbon fines into the plating bath. In addition, the carbon that is used is an ultra-clean, highly purified carbon to ensure that sulfur is not leached into the plating bath.

ELPC Series products have a 10- micron nominal rating with superior dirt-holding ability.

The fibrous physical structure created by our proprietary Fibredyne technology produces a unique block with true depth filtration capability which allows for maximum treatment with minimal pressure drop through the cartridge.



Item #	Description	Maximum Dimensions	Micron Rating (Nominal)	Initial ΔP (psi) @ Flow Rate (gpm)
25566843	ELPC-10	2-7/8" x 9-3/4" (73mm x 248mm)	10	3.4 psi @ 1 gpm (0.2 bar @ 3.8 Lpm)
25566943	ELPC-20	2-7/8" x 20" (73mm x 508mm)	10	3.4 psi @ 2 gpm (0.2 bar @ 7.6 Lpm)
25567043	ELPC-30	2-7/8" x 30" (73mm x 762mm)	10	3.4 psi @ 3 gpm (0.2 bar @ 11.4 Lpm)

## Materials of Construction

- **Filter Media** .....Bonded PAC
- **End Caps** .....Polypropylene
- **Netting** .....Polyethylene
- **Gaskets** .....Santoprene™
- **Temperature Rating** .....40°F to 180°F (4.4°C - 82.2°C)

**WARNING:** Do not use with water that is microbiologically unsafe or of unknown quality without adequate disinfection before or after the unit.

**NOTE:** Performance capacity depends on system design, flow rate and certain other application conditions. Certain states require system registration or certification for health-related contaminant reduction claims.

**NOTE:** Cartridges will contain a very small amount of carbon fines (very fine black powder). After installation, a new cartridge should be flushed with sufficient water to remove all traces of fines prior to using the water.

**NOTE:** Micron ratings based on 85% or greater removal of given particle size. Estimated capacity using 2ppm free available chlorine at 0.5 ppm breakthrough.

# CBC Series Carbon Briquette Cartridges

- Nominal 0.5-micron rating.\*
- 99.5% reduction of Cryptosporidium, Giardia, Entamoeba and Toxoplasma cysts.\*
- Premium high capacity bad taste & odor and chlorine taste & odor reduction.\*
- Enhanced dirt holding capacity.\*

CBC Series cartridges are highly effective at reducing unwanted taste, odor and chlorine: taste and odor from potable drinking water. The unique structure of the carbon block enables it to reduce Giardia, Cryptosporidium, Entamoeba and Toxoplasma cysts and fine sediment particles down to 0.5 microns.\*.

CBC Series cartridges are manufactured using a patented process and made entirely from FDA-approved materials. They are an ideal choice for a wide range of residential, food service, commercial and industrial applications. They also make excellent polishing filters or pre-filters in applications requiring fine filtration and high capacity.

\* Based on manufacturer's internal testing.



The CBC-10, CBC-20, CBC-BB and CBC-20BB are Tested and Certified by NSF International under ANSI/NSF Standard 42 for material requirements only.

COMPONENT

Item #	Description	Micron Rating (Nominal)*	Maximum Dimensions	Initial ΔP (psi) @ Flow Rate (gpm)*	Chlorine Reduction @ Flow Rate (gpm)*†
15516943	CBC-5	0.5	2-7/8" x 4-7/8" (73 mm x 124 mm)	7.0 psi @ 1 gpm (0.48 bar @ 3.8 lpm)	>3,000 gallons @ 1 gpm >11,400 litres @ 3.8 lpm
15516243	CBC-10	0.5	2-7/8" x 9-3/4" (73 mm x 248 mm)	3.7 psi @ 1 gpm (0.26 bar @ 3.8 lpm)	>20,000 gallons @ 1 gpm >75,700 litres @ 3.8 lpm
15530943	CBC-20	0.5	2-7/8" x 20" (73 mm x 508 mm)	3.0 psi @ 2 gpm (0.21 bar @ 7.6 lpm)	>45,000 gallons @ 2 gpm >170,300 litres @ 7.6 lpm
15517043	CBC-BB	0.5	4-5/8" x 9-3/4" (117 mm x 248 mm)	4.6 psi @ 2 gpm (0.32 bar @ 7.6 lpm)	>50,000 gallons @ 2 gpm >189,300 litres @ 7.6 lpm
15531243	CBC-20BB	0.5	4-5/8" x 20" (117 mm x 508 mm)	8.5 psi @ 4 gpm (0.59 bar @ 15.1 lpm)	>150,000 gallons @ 4 gpm >567,800 litres @ 15.1 lpm

## Materials of Construction

- **Filter Media** .....Bonded PAC
- **End Caps** .....Polypropylene
- **Inner/Outer Wraps** .....Polyolefin
- **Netting** .....Polyethylene
- **Gaskets** .....Buna-N
- **Temperature Rating** .....40°F to 180°F (5°C to 83°C)

**NOTE:** Performance capacity depends on system design, flow rate and certain other application conditions. Certain states require system registration or certification for health-related contaminant reduction claims.

**WARNING:** Do not use with water that is microbiologically unsafe or of unknown quality without adequate disinfection before or after the system.

**NOTE:** Cartridges will contain a very small amount of carbon fines (very fine black powder) and a new cartridge after installation should be flushed with sufficient water to remove all traces of the fines from your water system before using the water. Each time you use your filtered water tap for drinking or cooking purposes it is recommended that you run (flush) the tap for at least 20 seconds prior to using water.

**NOTE:** Micron ratings based on 85% or greater removal of given particle size.

**NOTE:** CBC-Series cartridges are capable of reducing 99.9% of Cryptosporidium and Giardia cysts. Data obtained from actual particle counts using AC Fine Test Dust and Latex spheres.

\* Based on manufacturer's internal testing.

†Estimated capacity using 2ppm free available chlorine (FAC) at continuous flow with greater than 90% reduction.

US Patent No. 5,976,432 & 5,823,668



# CCBC-10 Coconut Based Carbon Block Cartridges

- Nominal 1-micron rating.\*
- Water-washed coconut-carbon formulation.\*
- Premium high capacity bad taste & odor and chlorine taste & odor reduction.\*
- Enhanced dirt-holding capacity.\*

CCBC-10 cartridges are highly effective at reducing unwanted taste & odor and chlorine taste & odor from potable drinking water. With a nominal 1-micron rating, they are equally effective at reducing fine sediment.\*

CCBC-10 cartridges are manufactured using a patented process and made from a water-washed, coconut-carbon formulation. This process and media yields a cartridge with high chlorine taste & odor reduction capacity.

These cartridges are protected by Endurawrap™, a uniquely formulated polyolefin bilaminate pre-filter, designed to significantly increase the useful life of the cartridge by trapping sediment that typically plugs carbon block cartridges.

They are an ideal choice for a wide range of residential, food service, commercial and industrial applications. They also make excellent polishing filters or pre-filters in applications requiring fine filtration and high capacity.

SCBC Series are silver impregnated versions of the standard CCBC to help inhibit the growth of bacteria.

\* Based on manufacturer's internal testing.



CCBC-10



COMPONENT

This CCBC-10 is Tested and certified by NSF International to NSF/ANSI Standard 42 for material requirements only.

Item #	Description	Maximum Dimensions	Micron Rating (Nominal)*	Initial ΔP (psi) @ Flow Rate (gpm)	Chlorine Reduction @ Flow Rate (gpm)*
15571343	CCBC-10	2-7/8" x 9-3/4" (73mm x 248mm)	1	3.3 psi @ 1 gpm (0.23 bar @ 3.8 lpm)	>20,000 gallons @ 1 gpm (18,900 liters @3.8 lpm)
15535043	SCBC-10	2-7/8" x 9-3/4" (73mm x 248mm)	1	3.3 psi @ 1 gpm (0.23 bar @ 3.8 lpm)	>20,000 gallons @ 1 gpm (18,900 liters @3.8 lpm)

## Materials of Construction

- **Filter Media** .....Water-Washed Coconut Based Carbon
- **End Caps** .....Polypropylene
- **Inner/Outer Wraps** .....Polyolefin
- **Netting** .....Polyethylene
- **Gaskets** .....Buna-N
- **Temperature Rating** ....40°F to 180°F (5°C to 83°C)

**WARNING:** Do not use with water that is microbiologically unsafe or of unknown quality without adequate disinfection before or after the system.

US Patent No. 5,976,432 & 5,823,668

# CBR2 Series Carbon Briquette Multimedia Cartridges

- Nominal 0.5-micron rating.\*
- Lead reduction through 2000 gallons.\*
- VOC and MTBE reduction.\*
- 99.95% reduction of Cryptosporidium, Giardia, Entamoeba and Toxoplasma cysts.\*
- Premium high capacity chlorine taste & odor reduction through more than 20,000 gallons.\*
- Enhanced dirt holding capacity.\*

The CBR2-10 and CBR2-10R are advanced multimedia cartridges designed to reduce chlorine taste & odor, dissolved and particulate lead, cysts, MTBE and certain volatile organic chemicals (VOCs).\*

CBR2 Series cartridges are manufactured using a patented process, and combine powdered activated carbon (PAC) with a specially designed adsorbent medium for lead and mercury reduction.

These cartridges are protected by Endurawrap™, a uniquely formulated polyolefin bilaminate prefilter, designed to significantly increase the useful life of the cartridge by trapping sediment that typically plugs carbon block cartridges.

In addition to lead reduction, the unique structure of the carbon block enables it to reduce Giardia, Cryptosporidium, Entamoeba and Toxoplasma cysts and fine sediment particles down to 0.5 microns.\*

As with our standard CBC Series carbon block, both the CBR2-10 and CBR2-10R are more effective at reducing levels of chlorine taste & odor, MTBE and (VOCs).\*

The CBR2-10R has a built-in flow restrictor (0.6 gpm) to allow for maximum contact time.

\* Based on manufacturer's internal testing.



This CBR2-10 and CBR2-10R are Tested and certified by NSF International under ANSI/NSF Standard 42 for material requirements only.

Item #	Model	Maximum Dimensions	Micron Rating (Nominal)*	Initial ΔP (psi) @ Flow Rate (gpm)	Chlorine Reduction @ Flow Rate (gpm)*
15526843 (use 26118)	CBR2-10	2-7/8" x 9-3/4" (73mm x 247mm)	0.5	15 psi @ 1.0 gpm (1.0 bar @ 3.8 lpm)	>20,000 gallons @ 1.0 gpm (>75,700 liters @ 3.8 lpm)
15540343	CBR2-10R	2-7/8" x 9-3/4" (73mm x 247mm)	0.5	Flow restricted to 0.6 gpm (2.3 lpm) with built-in flow restrictor	>20,000 gallons @ 0.6 gpm (>75,700 liters @ 2.3 lpm)

## Materials of Construction

- **Filter Media** .....Bonded PAC
- **End Caps** .....Polypropylene
- **Outer Wrap** .....Polyolefin
- **Netting**.....Polyethylene
- **Gaskets** .....Buna-N
- **Temperature Rating** ..40°F to 165°F (5°C to 74°C)

**NOTE:** Certain states require system registration or certification for health-related contaminant reduction claims.

**NOTE:** Chlorine and lead reduction tests conducted by Pentek Filtration at 0.6 gallons per minute with a Pentek Filtration Slim Line™ (SL) housing.

**NOTE:** Meets NSF Standard 42 for chlorine I taste & odor reduction\*.

**CAUTION:** Do not use with water that is microbiologically unsafe or of unknown quality without adequate disinfection before or after the unit.

**NOTE:** Giardia, Cryptosporidium, Entamoeba and Toxoplasma cyst claim based on actual tests showing greater than 99.95% reduction using NSF Standard 53 protocol.

US Patent No. 5,976,432 & 5,823,668

# EP Series Carbon Briquette Cartridges

- Nominal 5-micron rating.\*
- High dirt-holding capacity maximizes utilization of the carbon block.\*
- Highly effective bad taste & odor and chlorine taste & odor reduction.\*

EP Series cartridges are versatile and combine the long life of carbon block filtration with the higher dirt-holding capacity of wound, carbon-impregnated paper cartridges like our C-1.

EP Series cartridges are manufactured using a patented process that yields a cartridge with a nominal 5-micron filtration rating, high dirt-holding capacity. A high porosity design helps prevent the cartridge from plugging before its adsorption capacity is exhausted, maximizing the utilization of the carbon while maintaining low pressure drop.

These cartridges are protected by Endurawrap™, a uniquely formulated polyolefin bilaminate pre-filter, designed to significantly increase the useful life of the cartridge by trapping sediment that typically plugs carbon block cartridges.

EP Series cartridges are manufactured entirely from FDA-compliant materials making them an ideal choice for a wide range of residential, food service, commercial and industrial applications.

\* Based on manufacturer's internal testing.

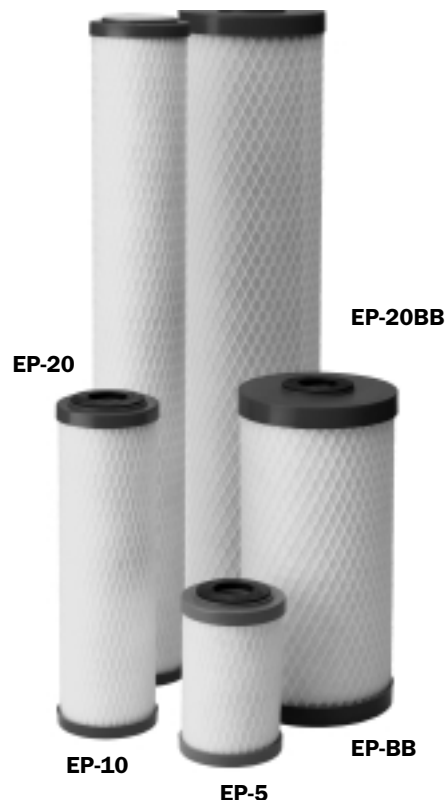

COMPONENT

The EP-10, EP-20, EP-BB and EP-20BB are Tested and Certified by NSF International to NSF/ANSI Standard 42 for material requirements only.

Item #	Description	Maximum Dimensions	Micron Rating (Nominal)*	Initial ΔP (psi) @ Flow Rate (gpm)	Chlorine Reduction @ Flow Rate (gpm)*
25542403	EP-5	2-7/8" x 4-7/8" (73mm x 124mm)	5	3.4 psi @ 1 gpm (0.23 bar @ 3.8 lpm)	>3,000 gallons @ 1 gpm (11,350 litres @ 3.8 lpm)
15553143	EP-10	2-7/8" x 9-3/4" (73mm x 247mm)	5	3.4 psi @ 1 gpm (0.23 bar @ 3.8 lpm)	>6,000 gallons @ 1 gpm (22,700 litres @ 3.8 lpm)
15552943	EP-20	2-7/8" x 20" (73mm x 508mm)	5	3.4 psi @ 2 gpm (0.23 bar @ 7.6 lpm)	>12,000 gallons @ 2 gpm (45,400 litres @ 7.6 lpm)
15554843	EP-BB	4-5/8" x 9-3/4" (117mm x 248mm)	5	4.3 psi @ 2 gpm (0.30 bar @ 7.6 lpm)	>22,000 gallons @ 2 gpm (83,300 litres @ 7.6 lpm)
15558343	EP-20BB	4-5/8" x 20" (117mm x 508mm)	5	5.5 psi @ 5 gpm (0.38 bar @ 19 lpm)	>40,000 gallons @ 4 gpm (151,400 litres @ 15.1 lpm)

## Materials of Construction

- **Filter Media** .....Bonded PAC
- **End Caps** .....Polypropylene
- **Inner/Outer Wraps** .....Polyolefin
- **Netting**.....Polyethylene
- **Gaskets** .....Buna-N
- **Temperature Rating** ....40°F to 180°F (5°C - 82.2°C)

**WARNING:** Do not use with water that is microbiologically unsafe or of unknown quality without adequate disinfection before or after the system.

**NOTE:** The EP cartridges will contain a very small amount of carbon fines (very fine black powder) and a new cartridge after installation should be flushed with sufficient water to remove the fines from your water system before using the water.

**NOTE:** Micron ratings based on 85% or greater removal of given particle size. Data obtained from actual particle counts using AC Fine Test Dust and Latex spheres.

**NOTE:** Estimated capacity using 2ppm free available chlorine (FAC) at continuous flow with greater than 90% reduction.

US Patent No. 5,976,432 & 5,823,668

# CEP-10E Series Coconut Based Carbon Block Cartridges

- Nominal 5-micron rating.\*
- Acid-washed coconut-carbon formulation.
- Bad taste & odor and chlorine taste & odor reduction.\*
- Low extractables, minimal pH rise for RO pre- and post-filter applications.\*
- Enhanced dirt holding capacity.\*

CEP-10E cartridges are manufactured from an acid-washed coconut-carbon based formulation that minimizes the pH rise and produces better tasting water.

Our patented manufacturing process yields a cartridge with a nominal 5- micron filtration rating, low extractables and a minimal pH rise ideal for RO pre- and post-filter applications. A thin-wall, high porosity design helps prevent the cartridge from plugging before its adsorption capacity is exhausted, maximizing the utilization of the carbon while maintaining low pressure drop.

These cartridges are protected by Endurawrap™, a uniquely formulated polyolefin bilaminate prefilter, designed to significantly increase the useful life of the cartridge by trapping sediment that typically plugs carbon block cartridges.

\* Based on manufacturer's internal testing.



CEP-10E



Tested and certified by NSF International to NSF/ANSI Standard 42 for material requirements only.

COMPONENT

Item #	Description	Maximum Dimensions	Micron Rating (Nominal)	Initial ΔP (psi) @ Flow Rate (gpm)	Chlorine Reduction @ Flow Rate (gpm)
15571443	CEP-10E	2-7/8" x 9-3/4" (73mm x 247mm)	5	3.0 psi @ 1 gpm (0.2 bar @ 3.8 lpm)	>5,000 gallons @ 1 gpm (>18,900 liters @ 3.8 lpm)

## Materials of Construction

- **Filter Media** .....Acid-Washed Coconut Based Carbon
- **End Caps** .....Polypropylene
- **Inner/Outer Wraps**.....Polyolefin
- **Netting**.....Polyethylene
- **Gaskets** .....Buna-N
- **Temperature Rating** ..40°F to 125°F (5°C to 52°C)

**WARNING:** Do not use with water that is microbiologically unsafe or of unknown quality without adequate disinfection before or after the system.

US Patent No. 5,976,432 & 5,823,668

# EPM Series Modified Epsilon Carbon Briquette Cartridges

- Nominal 10-micron rating.\*
- Highest carbon block dirt holding capacity for maximum cartridge life.\*
- Bad taste & odor and chlorine taste & odor reduction.\*
- Lowest pressure drop.
- Economically priced.

EPM Series cartridges are a modified version of our “EP Series” cartridge. An economical price makes this cartridge suitable for taste, odor and chlorine taste & odor reduction, as well as sediment filtration.\*

EPM Series cartridges are manufactured using a patented process that yields a cartridge with a nominal 10-micron filtration rating, high porosity and greater chlorine removal capacity than competitive 10 micron carbon blocks. The high porosity design helps prevent the cartridge from plugging before its adsorption capability is exhausted, maximizing the utilization of the carbon while maintaining low pressure drop.

They are an ideal choice for a wide range of residential, food service, commercial and industrial applications. They also make excellent polishing filters or pre-filters in applications requiring fine filtration and high capacity.

EPM Series cartridges are manufactured entirely from FDA-compliant materials making them an ideal choice for a wide range of residential, food service, commercial and industrial applications.

\* Based on manufacturer's internal testing.



Tested and certified by NSF International to NSF/ANSI Standard 42 for material requirements only.

## COMPONENT

Item #	Description	Maximum Dimensions	Micron Rating (Nominal)*	Initial ΔP (psi) @ Flow Rate (gpm)	Chlorine Reduction @ Flow Rate (gpm)*
15563443	EPM-10	2-7/8" x 9-3/4" (73mm x 247mm)	10	1.5 psi @ 1 gpm (0.10 bar @ 3.8 lpm)	>3,000 gallons @ 1 gpm (>11,400 liters @ 3.8 lpm)
15563543	EPM-20	2-7/8" x 20" (73mm x 508mm)	10	1.0 psi @ 2 gpm (0.07 bar @ 7.6 lpm)	>6,000 gallons @ 2 gpm (>22,700 liters @ 7.6 lpm)
15578243	EPM-BB	4-5/8" x 9-3/4" (117mm x 247mm)	10	5.0 psi @ 2 gpm (0.35 bar @ 7.6 lpm)	>15,000 gallons @ 2 gpm (>56,750 liters @ 7.6 lpm)
15578343	EPM-20BB	4-5/8" x 20" (117mm x 508mm)	10	4.0 psi @ 4 gpm (0.28 bar @ 15 lpm)	>30,000 gallons @ 4 gpm (>113,500 liters @ 15 lpm)

## Materials of Construction

- **Filter Media** .....Bonded PAC
- **End Caps** .....Polypropylene
- **Outer Wrap** .....Polyolefin
- **Netting**.....Polyethylene
- **Gaskets** .....Buna-N
- **Temperature Rating** ..40°F to 180°F (5°C to 83°C)

**NOTE:** Performance capacity depends on system design, flow rate and certain other application conditions.

**NOTE:** When greater chlorine reduction is needed, use the standard EP series blocks.

**WARNING:** Do not use with water that is microbiologically unsafe or of unknown quality without adequate disinfection before or after the system.

**NOTE:** EPM-Series cartridges will contain a very small amount of carbon fines (very fine black powder). After installation follow the instructions for flushing the cartridge to remove all traces of the fines before using the water. You should run (flush) the tap at least 20 seconds prior to using water for drinking or cooking purposes. This is particularly important if the tap has not been used daily.

US Patent No. 5,976,432 & 5,823,668

# Chloramine Reduction Carbon Cartridges

- Utilizes advanced activated carbon technology which results in excellent chloramine as well as superior chlorine reduction.
- CRFC20BB Radial Flow Cartridge.
- CGAC-10 Granular Activated Carbon Cartridge.
- ChlorPlus Series Carbon Briquette Cartridges.

PENTEK® offers three different product solutions for chloramine reduction. Chloramine is increasingly becoming more common as an alternative to chlorine for water treatment.

The CGAC-10 cartridge utilizes traditional granular activated carbon and is used for basic applications where chloramine must be removed. The construction of this cartridge allows water to pass evenly over a large bed of carbon while minimizing channeling or bypass.

The ChlorPlus™ carbon block cartridges will help reduce sediment while providing greater chloramine performance capacities than granular carbon. They will also significantly reduce the carbon fines found in many granular canisters.

The CRFC20-BB heavy duty radial flow cartridge measures 4-1/2" in diameter and 20" long which is ideal for higher flow rate and capacity applications. This cartridge incorporates a 70 micron porous polypropylene outer shell and a spun polypropylene-wrapped core. The bed of granular activated carbon (GAC) between the outer shell and core creates a unique radial flow design which effectively removes chloramine, has a low pressure drop, and helps to reduce fines commonly seen in GAC style cartridges.

All three products utilize advanced activated carbon technology which allows excellent chloramine reduction as well as superior chlorine reduction. The variety of sizes and capacities offered by PENTEK chloramine reduction cartridges make them ideal solutions for both point-of-entry (POE) and point-of-use (POU) applications.



Item #	Description	Maximum Dimensions	Micron Rating (Nominal)*	Initial ΔP (psi) @ Flow Rate (gpm)	Chlorine Taste & Odor Reduction @ Flow Rate	Chlorine Reduction @ Flow Rate (gpm)*
25541643	ChlorPlus10	2-7/8" x 9-3/4" (73mm x 248mm)	1	6 psi @ 1 gpm (0.41 bar @ 3.8 lpm)	>100,000 gallons @ 1 gpm (>378,500L @ 3.8 lpm)†	>3,000 gallons @ 1 gpm (>11,400 liters @ 3.8 lpm)
25541743	ChlorPlus20	2-7/8" x 20" (73mm x 508mm)	1	6 psi @ 2 gpm (0.41 bar @ 7.6 lpm)	>100,000 gallons @ 2 gpm (>757,000L @ 3.8 lpm)†	>6,000 gallons @ 2 gpm (>22,700 liters @ 7.6 lpm)
15566143	CGAC-10	2-7/8" x 9-3/4" (73mm x 248mm)	20	20 psi @ 1 gpm (1.38 bar @ 3.8 lpm)	>30,000 gallons @ 1 gpm (>113,500L @ 3.8 lpm)†	>15,000 gallons @ 2 gpm (>56,750 liters @ 7.6 lpm)
35505643	CRFC-BB	4-1/2" x 9-3/4" (114mm x 248mm)	20	2.5 psi @ 2.5 gpm (0.17 bar @ 9.5 lpm) <1 psi @ 1.5 gpm (<.07 bar @ 9.5 lpm)	>10,000 gallons @ 2 gpm (>37,900L @ 7.6 lpm)†	>30,000 gallons @ 4 gpm (>113,500 liters @ 15 lpm)
15596743	CRFC20-BB	4-1/2" x 20" (114mm x 508mm)	20	2.5 psi @ 2.5 gpm (0.17 bar @ 9.5 lpm) <1 psi @ 1.5 gpm (<.07 bar @ 9.5 lpm)	>200,000 gallons @ 4 gpm (>757,000L @ 15 lpm)†	>30,000 gallons @ 4 gpm (>113,500 liters @ 15 lpm)

## Materials of Construction

	ChlorPlus	CGAC-10	CRFC-BB/CRFC20-BB
• Filter Media	Advanced Bonded PAC	Advanced Granular Activated	Advanced Granular Activated
• End Caps	Polypropylene	Polystyrene	Polypropylene
• Inner Wrap/Core	Polyolefin	N/A	Spun Polypropylene
• Outer Wrap/Shells	Polyolefin	Polystyrene	Polyethylene
• Expansion Pad	N/A	Polypropylene	N/A
• Post Filter	N/A	Spun Polypropylene	Spun Polypropylene
• Netting	Polyethylene	N/A	N/A
• Gaskets	Buna-N	Buna-N (top) Santoprene (bottom)	Buna-N
• Temperature Rating	40°F to 125°F (5°C to 52°C)	40°F to 180°F (5°C to 83°C)	40°F to 125°F (5°C to 52°C)

**WARNING:** For drinking water applications, do not use with water that is microbiologically unsafe or of unknown quality without adequate disinfection before or after the system.

**NOTE:** Some harmless bacteria will attack cellulose media cartridges. If your cartridge seems to disintegrate, or has a musty or moldy odor, switch to a synthetic media cartridge or consult the manufacturer.

\*NOTE: Estimated capacity tested at given flow rate using 2 ppm free available chlorine to 0.5 ppm breakthrough.

NOTE: Increased flow rates may result in less effective chlorine reduction.

# GAC Series Granular Activated Carbon Cartridges

- Effective bad taste & odor and chlorine taste & odor reduction.\*
- Designed for maximum adsorption.
- Post-filter to reduce carbon fines.
- Available in a variety of sizes and flow rates.

GAC Series cartridges effectively reduce unwanted tastes, odor and chlorine from your drinking water.\* They are designed to allow maximum contact between the water and carbon, ensuring maximum adsorption.

The construction of the cartridge allows water to enter at one end and pass through the entire length of the carbon bed before exiting the other end of the cartridge, while an internal expansion pad minimizes channeling or bypass. Before the water exits the cartridge, a 20-micron post-filter helps reduce carbon fines and other suspended particles from the filtered water. The post-filter is permanently fastened to an innovative support basket ensuring that it is firmly secured and eliminating any potential for bypass.

GAC Series cartridges are available in a variety of sizes and flow rates, and effectively provide good general purpose drinking water filtration.

\* Based on manufacturer's internal testing.



COMPONENT

The GAC-10 and GAC-20BB are Tested and Certified by NSF International to NSF/ANSI Standard 42 for material requirements only.

Item #	Description	Maximum Dimensions	Initial ΔP psi @ Flow Rate GPM	Chlorine Reduction @ Flow Rate GPM*
15511003	GAC-5	2-7/8" x 4-7/8" (73 mm x 124 mm)	3.0 psi @ 0.5 gpm (0.25 bar @ 1.9 lpm)	250 gallons @ 0.5 gpm (900 liters @ 1.9 lpm)
15510943	GAC-10	2-7/8" x 9-3/4" (73 mm x 248 mm)	7.0 psi @ 1.0 gpm (0.5 bar @ 3.8 lpm)	5,000 gallons @ 1.0 gpm (18,900 liters @ 3.8 lpm)
15511143	GAC-20	2-7/8" x 20" (73 mm x 508 mm)	16 psi @ 2.0 gpm (1.1 bar @ 7.6 lpm)	10,000 gallons @ 2.0 gpm (37,800 liters @ 7.6 lpm)
15515343	GAC-BB	4-1/2" x 9-3/4" (114 mm x 248 mm)	6.0 psi @ 2.0 gpm (0.4 bar @ 7.6 lpm)	12,500 gallons @ 2.0 gpm (47,000 liters @ 7.6 lpm)
15524943	GAC-20BB	4-1/2" x 20" (114 mm x 508 mm)	5.0 psi @ 4.0 gpm (0.3 bar @ 15 lpm)	25,000 gallons @ 4.0 gpm (95,000 liters @ 15 lpm)

## Materials of Construction

- **Filter Media** .....Granular Activated Carbon
- **End Caps** .....Polystyrene
- **Post-Filter** .....Spun Polypropylene
- **Outer Casing** .....Polystyrene
- **Expansion Pad** .....Polypropylene
- **Gasket** .....Buna-N (top)  
Santoprene (bottom)
- **Temperature Rating** .....40°F to 125°F (4.4°C - 52°C)

**WARNING:** Do not use with water that is microbiologically unsafe or of unknown quality without adequate disinfection before or after the system.

**NOTE:** A drinking water cartridge may contain carbon fines (very fine black powder). After installation and before using the water, follow the instructions for flushing the cartridge to remove fines.

**NOTE:** It is recommended that you flush for 20 seconds prior to using the water for cooking purposes.

**NOTE:** Chlorine Reduction is estimated capacity using 2 ppm free available chlorine (FAC) at continuous flow with greater than 75% reduction.

# CC-10 Series Coconut Shell Granular Activated Carbon Cartridges

- Effective bad taste & odor and chlorine taste & odor reduction.\*
- Greater VOC reduction than standard GAC cartridges.\*
- Post-filter to reduce carbon fines.
- Available in a variety of sizes and flow rates.

CC Series granular activated carbon cartridges are an excellent choice to reduce unwanted chlorine taste & odor, and certain VOCs from potable drinking water. CC Series cartridges also reduce MTBE. They contain coconut shell based activated carbon, which produces drinking water of exceptional taste and quality and provides better VOC reduction than standard GAC cartridges.\*

The construction of the cartridge allows water to enter at one end and pass through the entire length of the carbon bed before exiting the other end of the cartridge, while an internal expansion pad minimizes channeling or bypass. Before the water exits the cartridge, a 20-micron post filter helps remove carbon fines and other suspended particles from the filtered water. The post filter is permanently fastened to an innovative support basket ensuring that it is firmly secured, eliminating any potential for bypass.

CC Series cartridges effectively provide good general-purpose drinking water filtration.

\* Based on manufacturer's internal testing.



This CC-10 and CC-20 are Tested and Certified by NSF International to NSF/ANSI Standard 42 for material requirements only.

COMPONENT

Item #	Description	Maximum Dimensions	Micron Rating (Nominal)*	Initial ΔP psi @ Flow Rate GPM	Chlorine Reduction @ Flow Rate GPM*
15515543	CC-10	2-7/8" x 9-3/4" (73 mm x 248 mm)	20	4.5 psi @ 1 gpm (0.3 bar @ 3.8 lpm)	7,500 gallons @ 1.0 gpm (28,000 liters @ 3.8 lpm)

## Materials of Construction

- **Filter Media** .....Granular Activated Carbon
- **End Caps**.....Polystyrene
- **Core** .....Spun Polypropylene
- **Outer Casing** .....Polystyrene
- **Expansion Pad** .....Polypropylene
- **Gasket** .....Buna-N (top)  
Santoprene (bottom)
- **Temperature Rating** .....40°F to 125°F (4.4°C - 52°C)

**NOTE:** Performance capacity depends on system design, flow rate and certain other application conditions. Certain states require system registration or certification for health-related reduction claims.

**WARNING:** For drinking water applications, do not use with water that is microbiologically unsafe or of unknown quality without adequate disinfection before or after the system.

**NOTE:** A drinking water cartridge may contain carbon fines (very fine black powder). After installation and before using the water, follow the instructions for flushing the cartridge to remove fines.

**NOTE:** It is recommended that you flush for 20 seconds prior to using the water for cooking purposes.



# TSGAC Specialty Granular Activated Carbon/Phosphate Cartridges

- Effective bad taste & odor and chlorine taste & odor reduction.\*
- Phosphate crystals reduce rust stains and scale deposits.\*
- Designed for maximum adsorption.
- Post filter to reduce carbon fines.

TSGAC cartridges contain granular activated carbon to effectively reduce unwanted taste & odor and chlorine taste & odor, as well as phosphate crystals to reduce rust stains and scale deposits.\*

The construction of the cartridge allows water to enter at one end and pass through the entire length of the carbon bed before exiting the other end of the cartridge. An internal expansion pad minimizes channeling or bypass. This design allows for maximum contact between the water and carbon, ensuring maximum adsorption.

Before the water exits the cartridge, a 20-micron post filter helps remove carbon fines and other suspended particles from the filtered water. The post filter is permanently fastened to an innovative support basket ensuring that it is firmly secured and eliminating any potential for bypass.

TSGAC cartridges provide superior performance and outstanding protection for your water lines, fixtures, major appliances and commercial equipment.

\* Based on manufacturer's internal testing.



COMPONENT

The TSGAC-10 Cartridge is tested and Certified by NSF International against ANSI/NSF Standard 42 - Conforms to material requirements.

Item #	Description	Maximum Dimensions	Initial ΔP (psi) @ Flow Rate (gpm)	Chlorine Reduction* @ Flow Rate (gpm)
15513143	TSGAC-10	2-7/8" x 9-3/4" (73mm x 248mm)	2.5 psi @ 1.0 gpm (0.2 bar @ 3.8 lpm)	>2,000 gallons @ 1 gpm (7,570 liters @ 3.8 lpm)

## Materials of Construction

- **Filter Media** .....Granular Activated Carbon  
Hexametaphosphate Crystals
- **End Caps** .....Polystyrene
- **Post-filter** .....Spun Polypropylene
- **Outer Casing** .....Polystyrene
- **Expansion Pad** .....Polypropylene
- **Gasket** .....Buna-N (top)  
Santoprene (bottom)
- **Temperature Rating** ....40°F to 125°F (4.4°C to 52°C)

**WARNING:** Do not use with water that is microbiologically unsafe or of unknown quality without adequate disinfection before or after the system.

**NOTE:** A drinking water cartridge may contain carbon fines (very fine black powder). After installation and before using the water, flush the cartridge for 5 minutes to remove fines.

**NOTE:** It is recommended that you run the tap for 20 seconds prior to using the water for drinking or cooking purposes.

# RFC Series Radial Flow Carbon Cartridges

- Provides effective chlorine taste & odor reduction.\*
- BB cartridges are ideal for point-of-entry (POE) and other high flow rate applications.
- Unique design reduces carbon fines in filtered water.
- Available in a wide variety of sizes.

RFC Series cartridges are constructed with a 70-micron porous polyethylene outer shell and durable polypropylene end caps. The 2-3/4" OD cartridges have a polypropylene core and the 4-1/2" OD cartridges incorporate a spun polypropylene core. Sandwiched between the outer shell and the core is a bed of granular activated carbon (GAC).

The unique radial flow design offers the benefits of granular activated carbon (GAC) filtration, such as low pressure drop, while at the same time significantly reducing the release of carbon fines commonly associated with GAC style cartridges.

RFC Series cartridges are available in a wide variety of sizes and are ideal point-of-entry (POE) and other high flow rate applications.

\* Based on manufacturer's internal testing.



The RFC20-BB is Tested and Certified by NSF International to NSF/ANSI Standard 42 for material requirements only.



Item #	Description	Maximum Dimensions	Initial ΔP (psi) @ Flow Rate (gpm)	Chlorine Taste & Odor Reduction @ Flow Rate (gpm)*
15506543	RFC-20	2-3/4" x 20" (70 mm x 508 mm)	0.60 psi @ 2 gpm (0.04 bar @ 7.6 L/min)	> 6,000 gallons @ 2 gpm 22,700 liters @ 7.6 L/min
15514143	RFC-BB	4-1/2" x 9-3/4" (114 mm x 248 mm)	0.90 psi @ 2 gpm (0.06 bar @ 7.6 L/min)	> 35,000 gallons @ 2 gpm 132,500 liters @ 7.6 L/min
15524743	RFC20-BB	4-1/2" x 20" (114 mm x 508 mm)	0.90 psi @ 4 gpm (0.06 bar @ 15.1 L/min)	> 70,000 gallons @ 4 gpm 265,000 liters @ 15.1 L/min

## Materials of Construction

- **Filter Media** .....Granular Activated Carbon
- **Outer Shell** .....Polyethylene
- **End Caps** .....Polypropylene
- **Gasket** .....Buna-N
- **Inner Wraps/Core** .....Polypropylene
- **Temperature Rating** .....40°F to 125°F (4.4°C to 51.7°C)

**WARNING:** Do not use with water that is microbiologically unsafe or of unknown quality without adequate disinfection before or after the system.

**NOTE:** The granular activated carbon cartridges will contain a very small amount of carbon fines (very fine black powder). After installation, a new cartridge should be flushed with sufficient water to remove all traces of the fines from your water system before using the water. Each time you use your filtered water tap for drinking or cooking purposes it is recommended that you run (flush) the tap for at least 20 seconds prior to using water. This is particularly important if the water tap has not been used daily.

# S1 Series Pleated Cellulose Sediment Cartridges

- Pleated design maximizes dirt-holding capacity.
- Designed for general water filtration purposes.
- Recommended for chlorinated water supplies.
- Economically priced.
- Nominal 20-micron rating.

S1 Series cartridges are manufactured from a pleated cellulose media and are designed for general water filtration purposes.

The media is pleated around a polypropylene core for added strength and the ends are immersed in a thermo-setting vinyl plastisol. Embedding and sealing each end of the pleat in this fashion fuses the three components together forming a unitized end cap and gasket.

An external netted sheath helps retain uniform pleat spacing in high flow and pulsating flow streams. The overlap seam is sonically welded to reduce bypass improving filtration efficiency.

S1 Series cartridges are economically priced and highly effective at reducing sediment particles down to 20-microns in size.

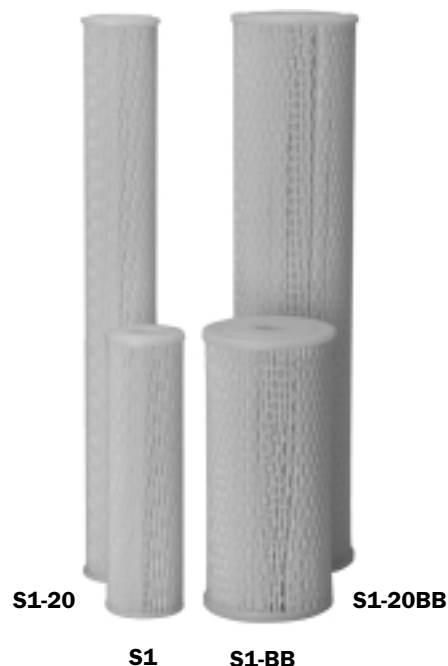

Item #	Description	Micron Rating (Nominal)	Initial ΔP (psi) @ Flow Rate (gpm)	Dimensions	Surface Area	Recommended Flow Rates
15500143	S1	20	2.4 psi @ 10 gpm (0.17 bar @ 38 lpm)	2-5/8" x 9-3/4" (67x248 mm)	586.21 in. <sup>2</sup> (1488.97 cm <sup>2</sup> )	12 GPM (45 LPM)
15530343	S1-20	20	0.8 psi @ 10 gpm (0.06 bar @ 38 lpm)	2-5/8" x 20" (67 x 508 mm)	1119.09 in. <sup>2</sup> (2842.49 cm <sup>2</sup> )	15 GPM (57 LPM)
15540543	S1-BB	20	1.2 psi @ 10 gpm (0.08 bar @ 38 lpm)	4-1/2" x 9-3/4" (114 x 248 mm)	2079.63 in. <sup>2</sup> (5282.26 cm <sup>2</sup> )	20 GPM (76 LPM)
15530543	S1-20BB	20	1.2 psi @ 10 gpm (0.08 bar @ 38 lpm)	4-1/2" x 20" (114 x 508 mm)	4289.86 in. <sup>2</sup> (10896.24 cm <sup>2</sup> )	25 GPM (95 LPM)

## Materials of Construction

- **Filter Media** .....Resin Impregnated Cellulose
- **End Caps** .....Vinyl Plastisol
- **Core** .....Polypropylene
- **Netting** .....Polyethylene
- **Temperature Rating** ..40°F to 145°F (4.4°C to 63°C)

**NOTE:** S1-BB and S1-20BB are for use in 10" and 20" Big Blue® housings and BBFS systems only.

**NOTE:** Big Blue® (BB) is a registered trademark of Pentek Filtration.

**WARNING:** Do not use with water that is microbiologically unsafe or of unknown quality without adequate disinfection before or after the system.

# R Series Pleated Polyester Cartridges

- Pleated design maximizes dirt-holding capacity.
- Versatile and reusable, allowing for a variety of uses.
- Durable polyester media is bacteria and chemical resistant.
- Nominal 30-micron rating (R-30) and nominal 50-micron rating (R-50).

R Series cartridges are manufactured from a durable, non-woven and reusable polyester fabric that is suitable for a wide range of filtration uses.

The media is pleated around a polypropylene core for added strength, and the ends are immersed in a thermo-setting vinyl plastisol. Embedding and sealing each end of the pleat block in this fashion fuses the three components, together forming a unitized end cap and gasket. The overlap seam is sonically welded to reduce internal bypass, improving filtration efficiency.

The standard 9-3/4" length cartridge has more than four square feet of polyester fabric, while the larger Big Blue® version has more than 16 square feet. The media is pleated to maximize dirt-holding capacity and extend the time period between changes or cleaning.

R Series cartridges are resistant to both bacteria and chemical attack making them suitable for a variety of residential, commercial and industrial applications.



This R50-BB is Tested and certified by NSF International to NSF/ANSI Standard 42 for material requirements only.

COMPONENT

Item #	Description	Maximum Dimensions	Micron Rating (Nominal)*	Initial ΔP (psi) @ Flow Rate (gpm)
15503153	R30-478	2-5/8" x 4-7/8" (67mm x 124mm)	30	<1 psi @ 10 gpm (<0.1 bar @ 38 lpm)
15501743	R30	2-5/8" x 9-3/4" (67mm x 248mm)	30	<1 psi @ 10 gpm (<0.1 bar @ 38 lpm)
15503843	R50	2-5/8" x 9-3/4" (67mm x 248mm)	50	<1 psi @ 10 gpm (<0.1 bar @ 38 lpm)
15541643	R30-20	2-5/8" x 20" (67mm x 508mm)	30	<1 psi @ 10 gpm (<0.1 bar @ 38 lpm)
15510143	R30-BB	4-1/2" x 9-3/4" (114mm x 248mm)	30	<1 psi @ 10 gpm (<0.1 bar @ 38 lpm)
15505343	R50-BB	4-1/2" x 9-3/4" (114mm x 248mm)	50	<1 psi @ 10 gpm (<0.1 bar @ 38 lpm)
15543043	R30-20BB	4-1/2" x 20" (114mm x 508mm)	30	<1 psi @ 20 gpm (<0.1 bar @ 76 lpm)

\*Based on manufacturer's internal testing.

## Materials of Construction

- **Filter Media** .....Non-Woven Polyester
- **End Caps** .....Vinyl Plastisol
- **Core** .....Polypropylene
- **Temperature Rating** ..40°F to 125°F (4.4°C to 52°C)

**WARNING:** Do not use with water that is microbiologically unsafe or of unknown quality without adequate disinfection before or after the system.

# PP Series Pleated Polypropylene Cartridges

- Pleated design maximizes dirt-holding capacity.
- Durable polypropylene media resists bacterial attack.
- Suitable for municipal or well water applications.
- Nominal 30-micron rating.

PP Series cartridges are manufactured from a durable polypropylene media. They are resistant to bacterial attack and compatible with a wide range of chemicals.

The high porosity of the media provides higher flow rates and dirt holding capacity, while maintaining extremely low pressure drop.

The media is pleated around a polypropylene core for added strength, and the ends are immersed in a thermo-setting vinyl plastisol. Embedding and sealing each end of the pleat block in this fashion fuses the three components together forming a unitized end cap and gasket.

An external netted sheath helps protect against particle migration in pulsating flow streams. The overlap seam is sonically welded to reduce internal bypass, improving filtration efficiency.

PP Series cartridges provide nominal 30-micron filtration and are highly effective at reducing medium/fine particles in a variety of residential, commercial and industrial applications.



Item #	Model	Maximum Dimensions	Micron Rating (Nominal)	Initial ΔP (psi) @ Flow Rate (gpm)
15512043	PP30-BB	4 1/2" x 9 3/4" (114mm x 248mm)	30	<1 psi @ 10 gpm (<0.1 bar @ 38 lpm)

## Materials of Construction

- **Filter Media**.....Non-Woven Polypropylene
- **End Caps** .....Vinyl Plastisol
- **Core**.....Polypropylene
- **Netting**.....Polyethylene (PP30 only)
- **Temperature Rating** ..40°F to 145°F (4.4°C to 63°C)

**WARNING:** For drinking water applications, do not use with water that is microbiologically unsafe or of unknown quality without adequate disinfection before or after the system.

# ECP Series Pleated Cellulose Polyester Cartridges

- Replaces CP and HFCP Series cartridges.
- Special formulation of resin-impregnated cellulose and polyester fibers. **ECP1-20**
- Provides higher wet strength than regular cellulose cartridges.
- Minimal unloading and media migration.

ECP Series cartridges are manufactured from a special formulation of resin-impregnated cellulose and polyester fibers.

This unique blend of materials provides a higher wet strength than regular cellulose cartridges. It also provides high flow rates and dirt-holding capacity, while maintaining extremely low pressure drop.

The media is pleated around a polypropylene core for added strength and the ends are immersed in a thermo-setting vinyl plastisol. Embedding and sealing each end of the pleat block in this fashion fuses the components together forming a unified end cap and gasket.

ECP Series cartridge end caps feature a color-coding system for easy identification of micron ratings: Tan (1-micron), White (5-micron), Blue (20-micron), Yellow (50-micron).

The new ECP cartridges contain more media surface area than most competitive cartridges. The standard 10" ECP cartridges contain six square feet of media, where most cartridges contain only 4.5 square feet. Additional ECP cartridges contain the following amount of media:

- Standard 20" cartridge – 12 ft<sup>2</sup>
- 10" BB cartridge – 18 ft<sup>2</sup>
- 20" BB cartridge – 36 ft<sup>2</sup>



Item #	Model	End Cap Color	Maximum Dimensions	Micron Rating (Nominal)	Initial ΔP (psi) @ Flow Rate (gpm)
25548143	ECP1-10	Tan	2-5/8" x 9-3/4" (67mm x 248mm)	1	<1 psi @ 10 gpm (<0.1 bar @ 38 Lpm)
25548243	ECP5-10	White	2-5/8" x 9-3/4" (67mm x 248mm)	5	<1 psi @ 10 gpm (<0.1 bar @ 38 Lpm)
25548343	ECP20-10	Blue	2-5/8" x 9-3/4" (67mm x 248mm)	20	<1 psi @ 10 gpm (<0.1 bar @ 38 Lpm)
25548443	ECP50-10	Yellow	2-5/8" x 9-3/4" (67mm x 248mm)	50	<1 psi @ 10 gpm (<0.1 bar @ 38 Lpm)
25548543	ECP1-20	Tan	2-5/8" x 20" (67mm x 508mm)	1	<1 psi @ 10 gpm (<0.1 bar @ 38 Lpm)
25548643	ECP5-20	White	2-5/8" x 20" (67mm x 508mm)	5	<1 psi @ 10 gpm (<0.1 bar @ 38 Lpm)
25548743	ECP20-20	Blue	2-5/8" x 20" (67mm x 508mm)	20	<1 psi @ 10 gpm (<0.1 bar @ 38 Lpm)
25548843	ECP50-20	Yellow	2-5/8" x 20" (67mm x 508mm)	50	<1 psi @ 10 gpm (<0.1 bar @ 38 Lpm)
25548943	ECP1-BB	Tan	4-1/2" x 9-3/4" (114mm x 248mm)	1	<1 psi @ 20 gpm (<0.1 bar @ 76 Lpm)
25549043	ECP5-BB	White	4-1/2" x 9-3/4" (114mm x 248mm)	5	<1 psi @ 20 gpm (<0.1 bar @ 76 Lpm)
25549143	ECP20-BB	Blue	4-1/2" x 9-3/4" (114mm x 248mm)	20	<1 psi @ 20 gpm (<0.1 bar @ 76 Lpm)
25549243	ECP50-BB	Yellow	4-1/2" x 9-3/4" (114mm x 248mm)	50	<1 psi @ 20 gpm (<0.1 bar @ 76 Lpm)
25549343	ECP1-20BB	Tan	4-1/2" x 20" (114mm x 508mm)	1	<1 psi @ 20 gpm (<0.1 bar @ 76 Lpm)
25549443	ECP5-20BB	White	4-1/2" x 20" (114mm x 508mm)	5	<1 psi @ 20 gpm (<0.1 bar @ 76 Lpm)
25549543	ECP20-20BB	Blue	4-1/2" x 20" (114mm x 508mm)	20	<1 psi @ 20 gpm (<0.1 bar @ 76 Lpm)
25549643	ECP50-20BB	Yellow	4-1/2" x 20" (114mm x 508mm)	50	<1 psi @ 20 gpm (<0.1 bar @ 76 Lpm)

## Materials of Construction

- **Media** .....Cellulose Polyester
- **End Caps** .....Vinyl Plastisol
- **Core** .....Polypropylene
- **Temperature Rating** ..40°F to 125°F (5°C to 52°C)

**WARNING:** Do not use with water that is microbiologically unsafe or of unknown quality without adequate disinfection before or after the system.

# PS Series Spun-Bonded Polypropylene Cartridges

- Manufactured from pure 100% polypropylene.
- Designed for purity and chemical compatibility.
- Spun fibers form a true gradient density from outer to inner surfaces.

Our new PS Series of poly spun-bonded filter cartridges are manufactured from pure 100% polypropylene fibers. The depth filtration cartridge construction offers greater performance flexibility in a broad range of solutions.

In water applications, polypropylene media will not impart taste, odor or colors into the solution. For industrial applications, polypropylene offers superior chemical resistance and is not prone to bacterial attack. The thermal bonding process of the media eliminates the need for a core support while offering resistance to collapse. This process also greatly reduces fiber migration.

PS Series cartridges are available in a wide range of lengths and micron sizes to accommodate a broad range of vessel sizes and applications.



Item #	Model	Maximum Dimensions	Micron Rating (Nominal)*	Initial ΔP (psi) @ Flow Rate (gpm)
25569043	PS1-10C	2-3/8" x 9-3/4" (60 mm x 248 mm)	1	2.9 psi @ 5 gpm (<0.2 bar @ 18.9 lpm)
25569143	PS1-20C	2-3/8" x 20" (60 mm x 508 mm)	1	1.45 psi @ 5 gpm (<0.1 bar @ 18.9 lpm)
25569243	PS1-30C	2-3/8" x 30" (60 mm x 762 mm)	1	0.97 psi @ 5 gpm (<0.1 bar @ 18.9 lpm)
25569343	PS1-40C	2-3/8" x 40" (60 mm x 1016 mm)	1	0.73 psi @ 5 gpm (<0.1 bar @ 18.9 lpm)
25569443	PS5-10C	2-3/8" x 9-3/4" (60 mm x 248 mm)	5	1.0 psi @ 5 gpm (<0.1 bar @ 18.9 lpm)
25569543	PS5-20C	2-3/8" x 20" (60 mm x 508 mm)	5	0.5 psi @ 5 gpm (<0.1 bar @ 18.9 lpm)
25569643	PS5-30C	2-3/8" x 30" (60 mm x 762 mm)	5	0.33 psi @ 5 gpm (<0.1 bar @ 18.9 lpm)
25569743	PS5-40C	2-3/8" x 40" (60 mm x 1016 mm)	5	0.25 psi @ 5 gpm (<0.1 bar @ 18.9 lpm)
25569843	PS20-10C	2-3/8" x 9-3/4" (60 mm x 248 mm)	20	0.7 psi @ 5 gpm (<0.1 bar @ 18.9 lpm)
25569943	PS20-20C	2-3/8" x 20" (60 mm x 508 mm)	20	0.35 psi @ 5 gpm (<0.1 bar @ 18.9 lpm)
25570043	PS20-30C	2-3/8" x 30" (60 mm x 762 mm)	20	0.23 psi @ 5 gpm (<0.1 bar @ 18.9 lpm)
25570143	PS20-40C	2-3/8" x 40" (60 mm x 1016 mm)	20	0.18 psi @ 5 gpm (<0.1 bar @ 18.9 lpm)

\*Based on manufacturer's internal testing.

## Materials of Construction

- **Filter Media** ..... Polypropylene Fibers
- **Temperature Rating** ..... 40°F to 145°F (4.4°C to 62.8°C)

**WARNING:** Do not use with water that is microbiologically unsafe or of unknown quality without adequate disinfection or after the system.

# P Series Spun Bonded-Polypropylene Cartridges

- Manufactured from pure 100% polypropylene.
- Designed for purity and chemical compatibility.
- Spun fibers form a true gradient density from outer to inner surfaces.

P Series cartridges are manufactured from pure 100% polypropylene fibers. The fibers have been carefully spun together to form a true gradient density from outer to inner surfaces.

P Series cartridges are designed for purity. They will not impart taste, odor or color to the liquid being filtered when used within the recommended temperature limit. Additionally, the polypropylene construction provides superior chemical resistance and is not prone to bacterial attack.

The coreless strength is achieved by sintering the many fibers into a solid matrix.

P Series cartridges are available in a wide array of sizes and micron ratings to accommodate all of your filtration needs.

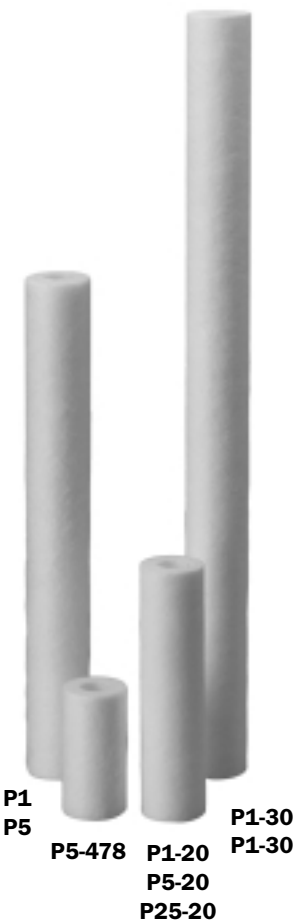

The P1, P5, P1-20 and P5-20 are Tested and Certified by NSF International to NSF/ANSI Standard 42 for material requirements only.

COMPONENT

Item #	Model	Maximum Dimensions	Micron Rating (Nominal)*	Initial ΔP (psi) @ Flow Rate (gpm)
15503043	P5-478	2-3/8" x 4-7/8" (61 mm x 124 mm)	5	0.3 psi @ 2 gpm (<0.1 bar @ 7.6 lpm)
15522543	P1	2-3/8" x 9-7/8" (61 mm x 251 mm)	1	0.6 psi @ 5 gpm (<0.1 bar @ 19 lpm)
15501443	P5	2-3/8" x 9-7/8" (61 mm x 251 mm)	5	0.2 psi @ 5 gpm (<0.1 bar @ 19 lpm)
15530405	P1-20	2-3/8" x 20" (61 mm x 508 mm)	1	0.6 psi @ 10 gpm (<0.1 bar @ 38 lpm)
15501605	P5-20	2-3/8" x 20" (61 mm x 508 mm)	5	0.6 psi @ 10 gpm (<0.1 bar @ 38 lpm)
15522605	P25-20	2-3/8" x 20" (61 mm x 508 mm)	25	0.2 psi @ 10 gpm (<0.1 bar @ 38 lpm)
15522706	P1-30	2-3/8" x 30" (61 mm x 762 mm)	1	0.5 psi @ 10 gpm (<0.1 bar @ 38 lpm)
15522806	P5-30	2-3/8" x 30" (61 mm x 762 mm)	5	0.2 psi @ 10 gpm (<0.1 bar @ 38 lpm)

\*Based on manufacturer's internal testing.

## Materials of Construction

- **Filter Media** .....Polypropylene Fibers
- **Temperature Rating** .....40°F to 145°F (4.4°C to 62.8°C)

**WARNING:** Do not use with water that is microbiologically unsafe or of unknown quality without adequate disinfection or after the unit.



# Polydepth® Polypropylene Sediment Cartridges

- Thermally bonded polypropylene micro-fiber construction for higher filtration efficiency.
- Consistent flow rate and superior filtration performance.
- Available in a wide range of micron ratings and lengths.
- Will not impart taste, odor or color to water being filtered.
- Ideal for a wide variety of industrial filtration.

The POLYDEPTH® filtration cartridge is constructed of thermally bonded polypropylene microfibers to ensure high efficiency. The filter media incorporates a rigid polypropylene center core for increased durability. This thermal bonded micro-fiber construction offers no fiber release, consistent flow rate and superior filtration performance. It also is not brittle or prone to breakage problems like resin-bonded cartridges.

Unique micro-grooves provide added surface area. The polydepth cartridge will not impart taste, odor or color to the liquid being filtered, which makes it ideal for food and beverage applications. The recommended temperature limit of 40°F to 175°F (4.4°C to 79.4°C) allows it to be used in many hot water applications. Additionally, the polypropylene construction provides superior chemical resistance and is not prone to bacterial attack.

Available in different lengths from 9-3/4" up to 40". Unlike competitive cartridges, the longer lengths are not manufactured from shorter cartridges that are glued together. They are continuous units that cannot separate during use. POLYDEPTH cartridges are available in various micron ratings including 1-, 5-, 10-, 25-, and 50-microns.



Item #	Model	Maximum Dimensions	Micron Rating (Nominal)	Initial ΔP (psi) @ Flow Rate (gpm)
15574843	PD-1-934	2- 1/2" x 9- 7/8" (64mm x 251mm)	1	All 9-7/8" cartridges are rated at <2 psi @ 2 gpm (<0.14 bar @ 7.6 lpm)
15575543	PD-1-20	2-1/2" x 20" (64mm x 510mm)	1	
15576243	PD-1-30	2-1/2" x 30" (64mm x 763mm)	1	
15576943	PD-1-40	2-1/2" x 40" (64mm x 1017mm)	1	All 20" cartridges are rated at <2 psi @ 5 gpm (<0.14 bar @ 19 lpm)
15574943	PD-5-934	2-1/2" x 9-7/8" (64mm x 251mm)	5	
15575643	PD-5-20	2-1/2" x 20" (64mm x 510mm)	5	
15576343	PD-5-30	2-1/2" x 30" (64mm x 763mm)	5	All 30" cartridges are rated at <2 psi @ 7 gpm (<0.14 bar @ 26.5 lpm)
15577043	PD-5-40	2-1/2" x 40" (64mm x 1017mm)	5	
15575043	PD-10-934	2-1/2" x 9-7/8" (64mm x 251mm)	10	
15575743	PD-10-20	2-1/2" x 20" (64mm x 510mm)	10	All 40" cartridges are rated at <2 psi @ 9 gpm (<0.14 bar @ 34 lpm)
15575143	PD-25-934	2-1/2" x 9-7/8" (64mm x 251mm)	25	
15575843	PD-25-20	2-1/2" x 20" (64mm x 510mm)	25	
15576543	PD-25-30	2-1/2" x 30" (64mm x 763mm)	25	
15577243	PD-25-40	2-1/2" x 40" (64mm x 1017mm)	25	
15575243	PD-50-934	2-1/2" x 9-7/8" (64mm x 251mm)	50	
15575943	PD-50-20	2-1/2" x 20" (64mm x 510mm)	50	

## Materials of Construction

- **Filter Media** .....Polypropylene
- **Maximum Temperature**..40°F to 175°F (4.4°C to

**WARNING:** Do not use with water that is microbiologically unsafe or of unknown quality without adequate disinfection before or after the

# DGD Series Dual-Gradient Density Cartridges

- Manufactured from 100% pure polypropylene.
- Designed for purity and chemical compatibility.
- Two separate gradient density layers enhance cartridge performance.
- Three times the dirt-holding capacity of similar sized sediment cartridges.

DGD Series cartridges are manufactured from 100% pure polypropylene and are sized for use in our Big Blue® filter housings.

DGD Series cartridges are designed for purity and will not impart taste, odor or color to the liquid being filtered. Additionally, the polypropylene construction provides superior chemical resistance and is not prone to bacterial attack.

The DGD Series advanced design combines selective “final filtration” with appropriate “pre-filtration” to achieve up to three times the dirt-holding capacity of similar size sediment cartridges and many more times that of standard spun or string-wound cartridges. This performance enhancement is achieved by combining two separate gradient layers in one filter.

The larger diameter of the pre-filter reduces the particle load to the post filter, allowing it to operate at higher velocities. The effective filter depth is increased to a full 233% of standard spun-polypropylene or string-wound filters. This increased depth provides for very high particulate reduction efficiencies and added loaded capacity.

The unique design and performance characteristics of the DGD Series cartridges make them an excellent choice for all residential, rural, municipal and commercial applications.



**DGD-2501-20**  
**DGD-5005-20**  
**DGD-7525-20**  
**DGD-2501**  
**DGD-5005**  
**DGD-7525**

Item #	Model	Maximum Dimensions	Micron Rating (Nominal)	Initial ΔP (psi) @ Flow Rate (gpm)
15535943	DGD-2501	4-1/2" x 10" (114 mm x 254 mm)	Pre-filter: 25; Post-filter: 1	<1 psi @ 10 gpm (<0.1 bar @ 38 lpm)
15536043	DGD-2501-20	4-1/2" x 20" (114 mm x 508 mm)	Pre-filter: 25; Post-filter: 1	<1 psi @ 20 gpm (<0.1 bar @ 76 lpm)
15535743	DGD-5005	4-1/2" x 10" (114 mm x 254 mm)	Pre-filter: 50; Post-filter: 5	<1 psi @ 10 gpm (<0.1 bar @ 38 lpm)
15535843	DGD-5005-20	4-1/2" x 20" (114 mm x 508 mm)	Pre-filter: 50; Post-filter: 5	<1 psi @ 20 gpm (<0.1 bar @ 76 lpm)
15535543	DGD-7525	4-1/2" x 10" (114 mm x 254 mm)	Pre-filter: 75; Post-filter: 25	<1 psi @ 10 gpm (<0.1 bar @ 38 lpm)
15535643	DGD-7525-20	4-1/2" x 20" (114 mm x 508 mm)	Pre-filter: 75; Post-filter: 25	<1 psi @ 20 gpm (<0.1 bar @ 76 lpm)

## Materials of Construction

- Filter Media .....Polypropylene
- Temperature Rating .....40°F to 145°F (4.4°C to 62.8°C)

**WARNING:** Do not use with water that is microbiologically unsafe or of unknown quality without adequate disinfection before or after the system.

# CW/WP Series Polypropylene Wound Cartridges

- String-wound design reduces fine sediment from a variety of fluids.
- Withstands temperatures up to 165°F (73.9°C)
- Economically priced.
- Nominal 10, 30, 50-micron rating (CW) and nominal 5, 30-micron rating (WP).

CW and WP Series cartridges are manufactured from a durable polypropylene cord that is wound around a rigid polypropylene core. They are an economical solution to reduce fine sediment, including sand, silt, rust and scale particles.

CW cartridges are very economical and wound in a standard pattern around the core. They are available in 10, 30 and 50-micron ratings.

WP Series cartridges are wound in a precise pattern around the core providing greater surface area. The result is higher dirt-loading capacity and greater efficiency than standard wound cartridges like the CW.

Both of these string-wound cartridge styles are capable of withstanding temperatures up to 165°F (73.9°C), and will accommodate flow rates between 7 and 10 GPM with minimal pressure drop.

CW and WP Series cartridges are suitable for a wide variety of sediment filtration applications, including municipal and well water as well as many industrial fluids.



Item #	Model	Maximum Dimensions	Micron Rating (Nominal)	Initial ΔP (psi) @ Flow Rate (gpm)
15518643	CW-F	2-3/8" x 9-7/8" (60mm x 251mm)	10	<1 psi @ 7 gpm (<0.1 bar @ 27 lpm)
15518743	CW-MF	2-3/8" x 9-7/8" (60mm x 251mm)	30	<1 psi @ 10 gpm (<0.07 bar @ 38 lpm)
15521443	CW-50	2-3/8" x 9-7/8" (60mm x 251mm)	50	<1 psi @ 10 gpm (<0.07 bar @ 38 lpm)
15507143	WP-5	2-3/8" x 9-7/8" (60mm x 251mm)	5	<2.5 psi @ 10 gpm (<0.17 bar @ 38 lpm)
15507243	WP-30	2-3/8" x 9-7/8" (60mm x 251mm)	30	<1.4 psi @ 10 gpm (<0.10 bar @ 38 lpm)

## Materials of Construction

- **Filter Media** .....Polypropylene Fiber Cord
- **Core** .....Polypropylene
- **Temperature Rating** .....40°F to 165°F (4.4°C to 73.9°C)

**WARNING:** Do not use with water that is microbiologically unsafe or of unknown quality without adequate disinfection before or after the system.

# Big Blue Polypropylene Wound Cartridges

The **WP-BB Series** cartridges are constructed of fibrous polypropylene media which has been wound around a polypropylene core. Available in nominal micron ratings ranging from 0.5 to 10, and both 9-7/8" and 20" lengths.

The **WPX-BB Series** cartridges are constructed of fibrillated polypropylene wound on a polypropylene core. The fibrillated polypropylene should be used when pressures require minimization of extractables and/or fiber migration. They are available in nominal micron ratings ranging from 5 to 100, and in both 9-7/8" and 20" lengths.



WP5BB97P



WPX5BB97P

Item #	Model	Maximum Dimensions	Micron Rating (Nominal)	Max Recommended Flow Rate	Pressure Drop
26100/ 35521243	WP5BB97P	4-1/2" x 9-7/8" (114 mm x 251 mm)	0.5	10 gpm (38 lpm)	5 psi (0.3 bar)
150100/ 35521343	WP1BB97P	4-1/2" x 9-7/8" (114 mm x 251 mm)	1	15 gpm (57 lpm)	4 psi (0.3 bar)
26101/ 35521443	WP5BB97P	4-1/2" x 9-7/8" (114 mm x 251 mm)	5	20 gpm (76 lpm)	3 psi (0.2 bar)
26102/ 35521543	WP10BB97P	4-1/2" x 9-7/8" (114 mm x 251 mm)	10	20 gpm (76 lpm)	1 psi (0.1 bar)
26103/ 35521643	WP25BB97P	4-1/2" x 9-7/8" (114 mm x 251 mm)	25	20 gpm (76 lpm)	1 psi (0.1 bar)
26127/ 35522243	WP1BB20P	4-1/2" x 20" (114 mm x 508 mm)	1	30 gpm (114 lpm)	6 psi (0.4 bar)
70004/ 35522343	WP5BB20P	4-1/2" x 20" (114 mm x 508 mm)	5	40 gpm (151 lpm)	6 psi (0.4 bar)
26128/ 35522543	WP25BB20P	4-1/2" x 20" (114 mm x 508 mm)	25	40 gpm (151 lpm)	5 psi (0.3 bar)
26104/ 35521743	WPX5BB97P	4-1/2" x 9-7/8" (114 mm x 251 mm)	5	10 gpm (38 lpm)	16 psi (1.1 bar)
26123/ 35521843	WPX10BB97P	4-1/2" x 9-7/8" (114 mm x 251 mm)	10	15 gpm (57 lpm)	12 psi (0.8 bar)
26124/ 35521943	WPX25BB97P	4-1/2" x 9-7/8" (114 mm x 251 mm)	25	20 gpm (76 lpm)	10 psi (0.7 bar)
26125/ 35522043	WPX50BB97P	4-1/2" x 9-7/8" (114 mm x 251 mm)	50	30 gpm (114 lpm)	8 psi (0.6 bar)
26126/ 35522143	WPX100BB97P	4-1/2" x 9-7/8" (114 mm x 251 mm)	100	40 gpm (151 lpm)	8 psi (0.6 bar)
26129/ 35522643	WPX100BB20P	4-1/2" x 20" (114 mm x 508 mm)	100	65 gpm (246 lpm)	8 psi (0.6 bar)

## Materials of Construction

- **Construction** .....Fibrous Polypropylene, Polypropylene Core
- **Temperature Rating** .....40°F to 165°F (4.4°C to 73.9°C)

**WARNING:** Filter must be protected from freezing which can cause cracking of the filter and water leakage. For drinking water applications, do not use with water that is microbiologically unsafe or of unknown quality without adequate disinfection or after the unit.

## BP, BPHE & BN Series Filter Bags

- Thermally welded unique design results in consistent filtration efficiencies.
- Semi-rigid cylindrical design is easily crushed and incinerated.
- Higher productivity - faster bag “change-outs.”

Woven monofilament materials are offered in nylon with micron rates of 50-800 and efficiencies from 75 to 95 percent. The materials are cleanable and reusable.

\* **Call for availability**

Polypropylene bags are compatible with a broad range of corrosive fluids including organic solvent, oils, acids, alkalis and micro-organisms.

### **BP Series (Polypropylene Felt) Bags**

An assortment of filtration ratings is offered - from 1 to 200 microns - to comply with any filtration requirement.

The bags are manufactured from felt because of its high solids loading capabilities, in comparison to similar mesh fabrics. The media is created by needle-punching two layers of synthetic fibers together in a supporting scrim. A glazed finish, created by melting the outermost surface fibers, is used to produce a bond that reduces the possibility of migration.

### **BPHE Series (High Efficiency) Bags\***

High efficiency bags are offered for those critical applications when high efficiency combined with high dirt-holding capacity is required. Polypropylene materials are processed into microfibers with diameters of 1-10 microns or more. These fibers are converted into filter material. Microfiber media are covered with spun-bonded polypropylene.



Item #	Model	Dimensions	Filter Media	Micron Rating	Case Quantity
15538303	BP-410-1 (10")	BP-410 4" x 8-5/8" (102 mm x 218 mm)	Glazed Polypropylene Felt	1	20
15538403	BP-420-1 (20")			1	20
15538503	BP-410-5 (10")			5	20
15538603	BP-420-5 (20")			5	20
15538703	BP-410-10-(10")			10	20
15538803	BP-420-10 (10")			10	20
15538903	BP-410-25 (20")			25	20
15539003	BP-420-25 (10")			25	20
15539103	BP-410-50 (10")			50	20
15539203	BP-420-50 (20")			50	20
15539303	BP-410-100 (10")	BP-420 4" x 18" (102 mm x 457 mm)	100	20	
15539403	BP-420-100 (20")		100	20	
15539503	BP-410-200 (10")		200	20	
15539503	BP-420-200 (20")		200	20	

### **Materials of Construction**

- **Maximum Temperature** .....200°F (93.3°C) (bags only)

See application literature for housing rating.

**WARNING:** For drinking water applications, do not use with water that is microbiologically unsafe or of unknown quality without adequate disinfection before or after the system.

**NOTE:** This information is for general guidance. Users should test bag materials with media involved to determine compatibility.

**CAUTION:** Protect against freezing which can cause cracking of the filter and water leakage.

# Quick-Change Filtration Systems

- Easy to install, easy filter change.
- Unique cover for single unit for a more appealing look.
- Reversible metal brackets for 1, 2 or 3 cartridges†
- 1/4-inch or 3/8-inch John Guest® push-fit connections available.
- 1/4-inch compression connections available for flex hose connections.
- Seven cartridge models to choose from to meet specific application needs.

†The Twin and Triple systems are not performance tested or certified by NSF.

PENTEK® Quick Change Filtration Systems are designed for easy installation and cartridge change. 1/4-inch or 3/8-inch push fittings, as well as 1/4-inch compression fittings, on the inlet and outlet sides of the filter head allow effortless installation. Many single systems are NSF Certified.

The cartridge filter is easily changed with a quarter-turn of the filter. Water is automatically shut off during the change of the filter through the auto shut-off feature built into the filter head. This feature eliminates the need for additional shut-off valves to and from the filter system.

The PENTEK quick-change filter system offers several cartridge options to meet the demands of varying water conditions. The granular activated carbon cartridge offers extended chlorine taste and odor performance with low pressure drop.\* The EP carbon block filter offers superior chlorine taste and odor performance with 5 micron sediment reduction.\* The CBR carbon block cartridge has enhanced performance capabilities for chlorine taste & odor, cyst, lead, atrazine and lindane reduction.

The new cartridges include carbon/phosphate cartridge, chloramine reduction cartridge, sediment only cartridge, a high performance 1-micron carbon block cartridge, and the soon to be released membrane filter cartridge for bacteria and virus reduction.\*

\*Not performance tested or certified by NSF.

- #144842 QCH 1/4" Threaded Replacement Head
- #244426 QCH 1/4" PF Replacement Head
- #244427 QCH 3/8" PF Replacement Head
- #244435 QC Replacement Head 1/4" JGPF New Design
- #244436 QC Replacement Head 3/8" JGPF New Design
- #15578543 QC-210-CBR-RP Replacement Cartridge
- #15596243 QC-210-EP-RP Replacement Cartridge
- #15590143 QC-210-GAC-RP Replacement Cartridge
- #25570643 QC10-TSGACR Replacement Cartridge
- #25570443 QC10-CGACR Replacement Cartridge
- #25570543 QC10-CB1R Replacement Cartridge
- #25568843 QC10-Sed1R Replacement Cartridge



\* Shown with optional designer cover



COMPONENT

The QC10-CBR is Tested and Certified by NSF/ANSI to Standard 42 for the reduction of Chlorine Taste & Odor and Particulate Class 1. Standard 53 Atrazine, Cyst, Lead, Lindane and Turbidity.

QC10-EP is Tested and Certified by NSF/ANSI to Standard 42 for the reduction of Chlorine Taste & Odor.

QC10-GAC is Tested and Certified by NSF/ANSI to Standard 42 for the reduction of Chlorine Taste & Odor.

# Quick-Change Filtration Systems Specifications

Item #			Model	Cartridge Color	Claims	Filter Life	Flow Rate	Micron Rating
1/4" Threaded	1/4" JG Push Fit	3/8" JG Push Fit						
158667	158682	158691	QC10-CBR	White	chlorine taste & odor, sediment, lead, atrazine, lindane, cyst & turbidity	500 gallons (1890 L)	0.5 gpm (1.9 lpm)	0.5
-	158683	-	QC10-EP	White	chlorine taste & odor	1,500 gallons (5670 L)	0.5 gpm (1.9 lpm)	5*
-	158684	-	QC10-GAC	Blue	chlorine taste & odor	2,500 gallons (9460 L)	0.75 gpm (2.8 lpm)	-
-	158723	158724	QC10-TSGAC†	Blue	chlorine taste & odor with phosphate crystals†	1,700 gallons (6435 L)*	0.75 gpm (2.8 lpm)	-
-	158719	158720	QC10-CGAC†	Blue	chloramine taste & odor and chlorine taste & odor†	500 gal. (1890 L) chloramine* 10,000 gal. (37850 L) chlorine*	0.6 gpm (2.3 lpm)	-

\*Filter life based on chlorine reduction as tested by Pentek.

†Not Performance Tested or Certified by NSF.

**CAUTION:** Protect against freezing to prevent cracking of the filter housing and water leakage.

**NOTE:** Cartridge will contain a very small amount of carbon fines (a very fine black powder). After installation and before using the water follow the instructions for flushing the cartridge to remove fines.

U.S. Patent Numbers: 5,976,432 and 5,823,668

# Gold In-Line Filtration Systems

- 5 body styles of in-line filters in multiple media configurations.
- Injection molded and pressure rated to 125 psi (8.62 bar).
- All in-line filters include a pre- and post-filter.

The new PENTEK Gold Series® in-line filters offer an extensive variety of products to meet your most challenging applications. PENTEK in-line filters are designed for use on any point of use drinking water appliance including reverse osmosis (RO) systems, distillation systems, coffee and espresso brewers, food service equipment, ice machines, misters, bottleless water coolers, water fountains, refrigerators and other water dispensing devices.

Gold Series® in-line filtration features coconut shell granular activated carbon. Various combinations of media are used to support a wide range of filtration applications. These combinations include FDA compliant hexam-etaphosphates, KDF® 55 and KDF® 85 media, gradient depth sediment filters, calcite media, cation softening resins and mixed bed deionization (DI) resins to meet the wide variety of aesthetic improvements required.

The in-line filtration systems also offer a wide variety of end termination and fitting options including 1/4" and 3/8" female NPT, 1/4" and 3/8" female Quick Connect (John Guest® style), 1/4" OD Stem and 1/4" male Jaco thread.



Item #	Model	Microns (nominal)	Volume (cubic ft)	Weight (lbs)	Case Quantity
<b>Bituminous Granular Activated Carbon</b>					
25549943	GS-6-B-1/4" FPT 2" x 6"	20	0.24	6	12
25550143	GS-6-G-1/4" John Guest® 2" x 6"	20	0.24	6	12
25550243	GS-6-H-3/8" John Guest® 2" x 6"	20	0.24	6	12
25550343	GS-10-B-1/4" FPT 2" x 10"	20	0.37	9	12
25550543	GS-10-G-1/4" John Guest® 2" x 10"	20	0.37	9	12
25550643	GS-10-H-3/8" John Guest® 2" x 10"	20	0.37	9	12
25550743	GS-210-B-1/4" FPT 2.5" x 11"	20	0.61	10	12
25550843	GS-210-C-3/8" FPT 2.5" x 11"	20	0.61	10	12
25551443	GS-215-H-3/8" John Guest® 2.5" x 14"	20	0.61	12	12
<b>Coconut Shell Granular Activated Carbon</b>					
25551543	GS-6RO-B-1/4" FPT 2" x 6"	5	0.24	6	12
25551943	GS-6RO-G-1/4" John Guest® 2" x 6"	5	0.24	6	12
25552143	GS-10RO-B-1/4" FPT 2" x 10"	5	0.37	12	12
25552243	GS-10RO-C-3/8" FPT 2" x 10"	5	0.37	12	12
25552543	GS-10RO-G-1/4" John Guest® 2" x 10"	5	0.37	12	12
25552643	GS-10RO-H-3/8" John Guest® 2" x 10"	5	0.37	12	12
25552843	GS-210RO-C-3/8" FPT 2.5" x 11"	5	0.61	14	12
25553143	GS-215RO-B-1/4" FPT 2.5" x 14"	5	0.61	18	12
<b>pH Stabilizer (Calcite &amp; Coconut Shell Carbon) Post RO</b>					
25554143	GS-10CAL/RO-B-1/4" FPT 2" x 10"	20	0.37	13	12
25554643	GS-10CAL/RO-H-3/8" John Guest® 2" x 10"	20	0.37	13	12
<b>Bacteriostatic (KDF &amp; Coconut Shell Carbon)</b>					
25554743	GS-6EXTRA.25-B-1/4" FPT 2" x 6"	5	0.24	10	12
25554843	GS-6EXTRA.25-C-3/8" FPT 2" x 6"	5	0.24	10	12
25555143	GS-6EXTRA.25-G-1/4" John Guest® 2" x 6"	5	0.24	10	12
25555343	GS-10EXTRA.5-B-1/4" FPT 2" x 10"	5	0.37	15	12
25555443	GS-10EXTRA.5-C-3/8" FPT 2" x 10"	5	0.37	15	12
25555743	GS-10EXTRA.5-G-1/4" John Guest® 2" x 10"	5	0.37	15	12
25555943	GS-210EXTRA1-B-1/4" FPT 2.5" x 11"	5	0.61	24	12
25556043	GS-210EXTRA1-C-3/8" FPT 2.5" x 11"	5	0.61	24	12
25556143	GS-210EXTRA1-G-1/4" John Guest® 2.5" x 11"	5	0.61	24	12



# Gold In-Line Filtration Specifications

Item #	Model	Microns (nominal)	Volume (cubic ft)	Weight (lbs)	Case Quantity
<b>Sediment &amp; Rust Particulate</b>					
25556943	GS-6SED/5-B-1/4" FPT 2" x 6"	5	0.24	5	12
25557343	GS-6SED/5-G-1/4" John Guest® 2" x 6"	5	0.24	5	12
25557643	GS-10SED/5-C-3/8" FPT 2" x 10"	5	0.37	7	12
25557943	GS-10SED/5-G-1/4" John Guest® 2" x 10"	5	0.37	7	12
25558243	GS-210SED/5-C-3/8" FPT 2.5" x 11"	5	0.61	14	12
25558743	GS-215SED/5-G-1/4" John Guest® 2.5" x 14"	5	0.61	18	12
25558843	GS-215SED/5-H-3/8" John Guest® 2.5" x 14"	5	0.61	18	12
<b>Lime, Scale, &amp; Chlorine Taste &amp; Odor (Hexametaphosphate &amp; Coconut Shell Carbon)</b>					
25558943	GS-6ALS-B-1/4" FPT 2" x 6"	20	0.24	6	12
25559043	GS-6ALS-C-3/8" FPT 2" x 6"	20	0.24	6	12
25559343	GS-6ALS-G-1/4" John Guest® 2" x 6"	20	0.24	6	12
25559543	GS-10ALS-B-1/4" FPT 2" x 10"	20	0.37	10	12
25559643	GS-10ALS-C-3/8" FPT 2" x 10"	20	0.37	10	12
25559943	GS-10ALS-G-1/4" John Guest® 2" x 10"	20	0.37	10	12
25560043	GS-10ALS-H-3/8" John Guest® 2" x 10"	20	0.37	10	12
<b>Lime &amp; Scale (Hexametaphosphate Feeder)</b>					
25560143	GS-6PH-B-1/4" FPT 2" x 6"	–	0.24	13	12
25560343	GS-10PH-B-1/4" FPT 2" x 10"	–	0.24	22	12
25560443	GS-10PH-G-1/4" John Guest® 2" x 10"	–	0.24	22	12
<b>Chlorine Taste &amp; Odor - 1 Micron Carbon Block Filters</b>					
25560943	GS-6CB-1-G-1/4" John Guest® 2" x 6"	1	0.24	5	12
25561543	GS-10CB-1-G-1/4" John Guest® 2" x 10"	1	0.37	9	12
25561643	GS-10CB-1-H-3/8" John Guest® 2" x 10"	1	0.37	9	12
25561743	GS-210CB-1-B-1/4" FPT 2.5" x 11"	1	0.61	11	12
25561843	GS-210CB-1-C-3/8" FPT 2.5" x 11"	1	0.61	11	12
<b>Chlorine Taste &amp; Odor - 5 Micron Carbon Block Filters</b>					
25562543	GS-6CB-5-B-1/4" FPT 2" x 6"	5	0.24	5	12
25562643	GS-6CB-5-C-3/8" FPT 2" x 6"	5	0.24	5	12
25562943	GS-6CB-5-G-1/4" John Guest® 2" x 6"	5	0.24	5	12
25563043	GS-6CB-5-H-3/8" John Guest® 2" x 6"	5	0.24	5	12
25563143	GS-10CB-5-B-1/4" FPT 2" x 10" 5 0.37	9	12		
25563243	GS-10CB-5-C-3/8" FPT 2" x 10" 5 0.37	9	12		
25563543	GS-10CB-5-G-1/4" John Guest® 2" x 10"	5	0.37	9	12
25563643	GS-10CB-5-H-3/8" John Guest® 2" x 10"	5	0.37	9	12
25563743	GS-210CB-5-B-1/4" FPT 2.5" x 11"	5	0.61	11	12
25563943	GS-210CB-5-G-1/4" John Guest® 2.5" x 11"	5	0.61	11	12
25564143	GS-215CB-5-B-1/4" FPT 2.5" x 14"	5	0.61	13	12
25564243	GS-215CB-5-C-3/8" FPT 2.5" x 14"	5	0.61	13	12
25564343	GS-215CB-5-G-1/4" John Guest® 2.5" x 14"	5	0.61	13	12
25564443	GS-215CB-5-H-3/8" John Guest® 2.5" x 14"	5	0.61	13	12
<b>Lead, Cyst, Particulate, &amp; Chlorine Taste &amp; Odor Filters</b>					
25564943	GS-10LS-G-1/4" John Guest® 2" x 10"	0.5	0.37	9	12
25565143	GS-210LS-B-1/4" FPT 2.5" x 11"	1	0.61	15	12
<b>TDS Reduction - High Capacity DI Resin Filters</b>					
25565543	GS-210DI-B-1/4" FPT 2.5" x 11"	20	0.61	17	12
25565943	GS-215DI-B-1/4" FPT 2.5" x 11"	20	0.61	24	12
<b>INLINE FILTER CLIPS</b>					
244454	HF-CLIP1 – 2" Single Inline Filter Clip	–	–	–	100
244455	HF-CLIP2 – 2.5" Single Inline Filter Clip	–	–	–	100

# Sealed In-Line Series

- Provide bad taste & odor and chlorine taste & odor reduction.
- Injection molded and pressure rated to 125 psi.
- All in-line filters include a pre- and post-filter.

Sealed In-Line filters feature coconut shell, granular activated carbon, and are designed to reduce unwanted taste, odor and chlorine taste and odor.

The TS-101L contains a combination of GAC and polyphosphate crystals to inhibit lime/scale build-up.

All Sealed In-Line filters include a durable, injection molded polypropylene body and cap, pre- and post-filter and are pressure rated to 125 psi. Available with 1/4" NPT connections.

Sealed In-Line filters are an ideal choice for post-RO, under-sink, ice-maker and food service applications.

Contact factory regarding availability of other sizes and media.



The IC-101L and TS-101L are Tested and Certified by NSF International.

COMPONENT

Item #	Model	Media	Maximum Dimensions	Estimated Life	Flow Rate (gpm)
15507020	IC-100 (c/w fittings)	17 cu. in.	(51 mm x 270 mm)	(9,460 liters)	(2.8 L/min)
15508301	TS-100 (c/w fittings)	16 cu. in.	(51 mm x 270 mm)	(6,450 liters)	(2.8 L/min)

## Materials of Construction

- **Body** .....Polypropylene
- **Cap** .....Polypropylene
- **Pre-filter and Post-filter** .....Polypropylene
- **Carbon** .....Coconut Shell GAC
- **Maximum Temperature** .....100°F (37.8°C)
- **Operating Pressure**.....125 psi (8.62 bar)

**WARNING:** For drinking water applications, do not use with water that is microbiologically unsafe or of unknown quality without adequate disinfection before or after the system.

**NOTE:** Cartridges will contain a very small amount of fines (very fine powder) and new cartridges, after installation, should be flushed with sufficient water to remove all traces of fines from your water system before use. Each time you use your filtered water tap for drinking or cooking purposes, it is recommended that you run (flush) the tap for at least 10 seconds prior to using water. This is particularly important if the water tap has not been used daily.

**CAUTION:** Protect against freezing to prevent cracking of the filter and water leakage.

# CRE-1 Ceramic Cartridges

- Specially designed for cyst reduction and fine sediment filtration applications.
- 1/2" thick ceramic wall allows for many cleanings, extending cartridge life.
- Nominal 1-micron rating.

CRE-1 cartridges are manufactured from a sintered ceramic filtration media. They are designed and tested for the reduction of Cryptosporidium and Giardia cysts, and are ideal for fine sediment filtration applications.

The fine ceramic media will effectively trap dirt, sediment, and cysts down to 1-micron in diameter. A proper fit is ensured and water bypass is prevented through the use of a knife-edge seal.

CRE-1 cartridges are easily cleaned with water and a damp cloth, sponge or stiff nylon brush. They can be cleaned several times until the diameter at the smallest point is 1-1/2" or the circumference is 4-3/4", extending cartridge life.

Not for residential sale in the state of California.



Item #	Model	Maximum Dimensions	Micron Rating (Nominal)	Initial ΔP (psi) @ Flow Rate (gpm)
15515943	CRE-1	1 7/8" x 9 3/4" (48 mm x 248 mm)	1 (3-4 @ 99.95%)	19 psi @ 1 gpm (1.3 bar @ 3.8 lpm)

## Materials of Construction

- **Filter Media** .....Sintered Ceramic
- **End Caps** .....Thermoset Polymeric
- **Gaskets** .....Buna-N
- **Temperature** .....40° to 125°F (4.4° to 52°C)

**NOTE:** Performance depends on system design, flow rate, feed water quality and certain other application conditions. Certain states require system registration or certification prior to sale if health-related contaminant reduction claims are made. Not for residential sale in the state of California.

**NOTE:** Only a thin layer of ceramic is removed with each cleaning. It is not necessary to clean the cartridge until the original color is restored as water in some locations may stain or discolor the ceramic. Good hygiene and house keeping practices should always be used when cleaning the CRE-1 cartridge.

**HANDLE CARTRIDGE WITH CARE!** Sharp blows, dropping, or freezing can cause cracks in the ceramic. If the cartridge should be cracked or frozen, discard the damaged cartridge and replace it with a new cartridge.

**CAUTION:** Do not use where water is microbiologically unsafe or with water of unknown quality without adequate disinfection before or after the unit. Cartridge is specifically designed for sediment filtration and the reduction of Giardia and Cryptosporidium cysts, not to kill or filter bacteria.

# Microguard™ Membrane Filter Cartridges

- Absolute 0.15 micron particle retention for bacteria and protozoan cyst reduction.
- 99.9999% bacteria reduction (>6 Log).
- 99.9999% cyst reduction (>6 Log).
- Combined carbon block and sediment pre-filtration for extended life and chlorine taste and odor reduction.
- Utilizes patented\* highly asymmetric polyethersulfone membrane with proprietary hydrophilic formulation for immediate wetting and high flow.
- Double O-ring end cap seals for absolute sealing in PENTEK Seal-Safe™ 3G housings.

The Microguard™ membrane filters provide reliable bacteria and protozoan cyst reduction for safer and cleaner drinking water without incorporating chemicals into the media or adding chemicals to the filtered water. The Microguard carbon block membrane cartridge, MG-10MCB, is uniquely designed with integral carbon block and sediment pre-filtration for the reduction of chlorine taste and odor and for providing extended life of the internal membrane element. This cartridge has 2.5 times greater filtration surface area than some anti-microbial carbon blocks and operates at a higher flow rate with lower pressure drop. This makes the MG-10MCB ideal for Point-of-Use (POU) applications. The Microguard cartridges do not require USEPA registration and their effectiveness is not susceptible to common substances normally found in some waters, e.g., hydrogen sulfide (H<sub>2</sub>S), natural organic matter (NOM) and total dissolved solids (TDS).

The Microguard triple-element cartridge, MG-10T, is uniquely constructed with three membrane elements integrally sealed into one common cartridge design. This unique design allows for higher flow rates and longer life while still providing bacteria and cyst reduction, and is ideal for applications up to five gallons per minute. The life of the MG-10T can be extended using PENTEK carbon block or sediment pre-filtration options.



MG-10T

MG-10MCB

Item #	Model	Description	Maximum Length	Maximum Diameter	Micron Rating
25542043	MG-10MCB	Carbon Block/ Membrane	10.283" (261.18 mm)	2.875" (73 mm)	0.15 absolute rating
25541943	MG-10T	Triple Element (membrane only)	10.294" (261.47 mm)	3.0" (76 mm)	0.15 absolute rating
25568243	MG-CCBR	Coconut Carbon Lead/Cyst Reduction	10.294" (261.47 mm)	3.0" (76 mm)	0.15 absolute rating

## Materials of Construction

- **Membrane** .....Polyethersulfone
- **Membrane Assembly** .....Polystyrene, epoxy resin
- **Carbon Pre-Filter** .....MG-10MCB with Fibredyne™ technology contains activated carbon with synthetic Polymeric fibers and binders
- **End Caps/Body** .....Polystyrene, excluding the bottom of the MG-10MCB which is Polypropylene
- **O-ring Seals** .....EPDM
- **Netting** .....Polyolefin (10MCB only)

**NOTE:** These cartridges are not intended for converting wastewater or raw sewage into drinking water.

\*U.S. Patent No. 5,240,862

Not certified for sale in California, Iowa, Massachusetts and Wisconsin.

# Oil Adsorbing Cartridges

- Modified cellulose-based filter chemically bonds specifically with hydrocarbons and other pollutants such as dissolved and dispersed oils from water.
- Instantaneous adsorption, more effective than activated carbon.
- Up to 90 percent of total hydrocarbons are removed in a single pass.
- For use in 20-inch Big Blue® filter housings.

The OAC-20BB, made from modified cellulose-based filter media, is processed into sheets and assembled into cartridges for use in standard 20" Big Blue® filter housings.

### Features

- Instantaneous adsorption - up to 90 percent of total hydrocarbons removed in a single pass.
- High flow rates.
- Removed dissolved and dispersed oils.
- Low pressure drop.
- Media can hold 250-300 percent of its own weight, with no release of removed hydrocarbons.

### Applications

- Gas and oil facilities • Leisure/commercial shipping bilge water • Surface water runoff (truck stops, airports, parking lots) • Auto service stations
- Machine shops • Industrial processes • Factories and repair shops • Car and truck washes

### Installation

Certain applications may require pre-filtration

### Change-Out Frequency

Change-out frequency will depend on the oil burden they have to handle. Because no appreciable increase in pressure drop is observed during service life, the filter must be changed when its adsorption capacity is exhausted.



Item #	Model	Maximum Dimensions	Pressure Drop (at 5-10 gpm)	Recommended Flow Rate
15559603	OAC-20BB	Length: 20.125" (511 mm) Outside Diameter: 4.5" (114 mm) Core ID: 1.110" (28 mm)	0.2 - 1.0 psi (0.01-0.07 bar)	5-10 gpm (19-38 lpm)

### Materials of Construction

- **Media** .....Modified Cellulose
- **End Caps** .....PVC Plastisol
- **Center Core** .....Natural Polypropylene
- **Temperature Rating** .....40°F to 125°F (4.4°C to 52°C)
- **Outer Net**.....Polyethylene
- **Media Area** .....18 sq.ft. (1.6 sq.m.)
- **Weight** .....1.75 lbs (0.8 kg)

**NOTE:** Operating flow will vary based on applications, type of pollutants, flow rates, level of contamination.

**DISPOSAL:** Safe and acceptable method to meet all local and EPA regulations is recommended. End user is responsible for safe disposal of used cartridge at user's costs. Consult factory for additional information

# PCC Series Hexametaphosphate Crystal Cartridges

- Effective at treating scale, corrosion and iron problems.
- Ideal for a variety of food service equipment, as well as other types of water processing equipment.

PCC Series cartridges contain food-grade hexametaphosphate that dissolves slowly in water to inhibit scale and rust build-up.

This type of treatment is recommended for use with ice machines, coffee and vending machines, food service equipment, water heaters, air conditioning equipment and many other types of water processing equipment.

To best meet your needs, cartridges are available in four feeder sizes and all materials are FDA grade.

They are highly effective at treating scale, corrosion and iron problems for up to six months at various flow rates and feed concentrations.

The PCC212 and PCC218 cartridges are designed to fit #10 Standard or Slim Line® filter housings.

The PCC106 is an insert element that is placed in the center core of the cartridge. It is designed for use with standard 10" and 20" radial flow, sediment and carbon block filter cartridges.



Item #	Model	Dimensions	Recommended Flow Rate (gpm)
15510043	PCC1	2-7/8" x 9-5/8" (73mm x 244mm)	Up to 5 gpm (19 lpm)
15524803	PCC212	2-5/8" x 9-3/4" (67mm x 248mm)	1 to 1.5 gpm (4 to 6 lpm)
15525103	PCC218	2-5/8" x 9-3/4" (67mm x 248mm)	1.5 to 2.5 gpm (6 to 10 lpm)

## Materials of Construction

- **Filter Media** ..... Food Grade Polyphosphate
- **Shell** ..... Polypropylene
- **Post-filter** ..... Polypropylene (PCC212 & 218)
- **Gasket** ..... Buna-N (PCC212 & 218)
- **Temperature Rating** ..... 40°F to 100°F (4.4°C to 37.85°C)

**CAUTION:** Eye irritant. Contains sodium calcium hexametaphosphate. Avoid contact with eyes. In case of eye contact, flush with water for 15 minutes, get medical attention. Keep out of reach of children.

**WARNING:** For drinking water applications, do not use with water that is microbiologically unsafe or of unknown quality without adequate disinfection before or after the system.

**NOTE:** PCC212 and PCC218 cartridges are not recommended for main line water applications with flow rates exceeding 3.0 gpm (11.4 lpm).

**NOTE:** With steamers, the water should be flushed daily.

**CAUTION:** Do not use this cartridge on water that will be carbonated.

# RFFE20-BB Radial Flow Iron Reduction Cartridges

- Easily and effectively reduces up to 3 ppm of dissolved iron from water.
- Improves flavor and reduces the metallic taste caused by iron.
- Reduces the possibility of pipe and water heater damage.
- For use in 20-inch Big Blue® filter housings.

The RFFE20-BB cartridge is designed to provide an easy and effective method of reducing iron from water, which greatly improves the taste.

This cartridge helps to eliminate the orange and brown stains often found in sinks, toilets, tubs and other plumbing fixtures.

RFFE20-BB reduces the possibility of damage to pipes and water heaters and reduces up to 3 ppm dissolved iron.

It adds no harmful chemicals to the water, making it completely safe for drinking water applications.

The RFFE20-BB cartridge should be installed on the main cold water line after the pressure tank or water meter. For best results, pre-sediment and post-carbon treatment is recommended.



<b>Approximate Life of System*</b>				
<b>Iron Level in Water</b>	<b>Total Gallons Water Used</b>	<b>250 GPD (4 People)</b>	<b>125 GPD (2 People)</b>	<b>75 GPD (1 Person)</b>
3 ppm	26,000 gal.	104 days	208 days	416 days
2 ppm	40,000 gal.	160 days	320 days	640 days
1 ppm	80,000 gal.	320 days	640 days	1280 days
0.5 ppm	160,000 gal.	640 days	1280 days	N/A

\*Test results were obtained by using the RFFE20-BB in combination with an RFC20-BB cartridge.

## Recommended Operating Conditions

Item #	Model	pH	Manganese	Iron Bacteria	Silica	Iron	Hydrogen Sulfide
15526303	RFFE20-BB	>7.0	<1 ppm	None	<100 ppm	<3 ppm	None

## \*Typical Iron Filtration System

- **Approximate Cartridge Life** .....3 to 6 Months (family of four)
- **Maximum Operating Pressure\*\*** ..90 psi (6.2 bar)
- **Maximum Water Temperature** ....100°F (37.8°C)
- **Inlet/Outlet Connections** .....1" (2.54 cm)
- **Replacement Cartridges - Iron Filter**.....RFFE20-BB
- **Recommended Filter** - |Sediment .....R30 BB (two)  
- Carbon.....RFC20-BB

\*When used in a BBFS-222 system

\*\*CAUTION: If you suspect your water pressure will at any time exceed the maximum rating of 90 psi (6.2 bar), a pressure regulator must be installed before the system. This will guard against the pressure exceeding the maximum rating at any time. It is recommended that the pressure regulator be set at 75 psi (5.2 bar) or less.

**NOTE:** Water conditions outside of the above specified limits may lead to a shortened filtration life. If your water contains Iron Bacteria, shock chlorination is recommended.

**WARNING:** Do not use with water that is microbiologically unsafe or of unknown quality without adequate disinfection before or after the system.

**CAUTION:** Protect against freezing to prevent cracking of the filter and water leakage.

**NOTE:** The RFFE20-BB and RFC20-BB cartridges will contain a very small amount of fines (very fine powder) and new cartridges, after installation, should be flushed with sufficient water to remove all traces of fines from your water system before use.

# PCF Series Mixed Bed Deionization Cartridges

- Designed for deionizing water up to 16 megohms.
- All materials and construction are FDA-compliant.
- Three sizes and capacities.

PCF Series cartridges have been developed in response to the requirements for deionized water in many industries.

They have been manufactured using an FDA-compliant resin that has been subjected to additional post-production steps to minimize the total organic carbon (TOC) level.

These high-capacity, semi-conductor grade resin cartridges are ideal for use in pharmaceuticals, medical laboratories, cosmetics, and circuit board printing applications.

PCF Series cartridges are available in three sizes, flow rates and capacities. They are convenient and cost-effective for many applications where low levels of total organic carbon (TOC) and total dissolved solids (TDS) levels are required.

### Applications:

- Circuit board printing • Pharmaceutical use • Steam and humidification
- Cosmetics • Steam processors • Humidification systems • Recirculating/cooling towers • Power generating equipment • Medical/laboratory use
- Lasers • Jet water sprayers • Boiler make-up water



Item #	Model	Maximum Dimensions	Capacity Grains (mg TDS as CaCO <sub>3</sub> )	Initial ΔP (psi) @ Flow Rate (gpm)	Suggested Flow Rate
15527303	PCF1-10MB	2-2/3" x 9-3/4" (68 mm x 248 mm)	270 (17,500)	1.5 psi @ 0.25 gpm (0.1 bar @ 0.95 lpm)	0.25 gpm (0.95 lpm)
15527403	PCF1-20MB	2-2/3" x 20" (68 mm x 508 mm)	600 (38,800)	3.4 psi @ 0.5 gpm (0.23 bar @ 1.9 lpm)	.50 gpm (1.9 lpm)
15528103	BBF1-20MB	4-1/2" x 20" (114mm x 508 mm)	1,850 (120,000)	1.1 psi @ 1.25 gpm (0.76 bar @ 4.7 lpm)	1.25 gpm (4.7 lpm)

### Materials of Construction

- **Filter Media** .....Mixed Bed DI resins
- **End Caps** .....Polypropylene
- **Shell** .....Polypropylene
- **Pre-filter** .....Polypropylene
- **Post Filter** .....Polypropylene
- **Gaskets** .....Buna-N
- **Temperature Rating** ..40°F to 100°F (4.4°C to 37.8°C)

**WARNING:** For drinking water applications, do not use with water that is microbiologically unsafe or of unknown quality without adequate disinfection or after the unit.

**NOTE:** The above resin data is based on information obtained by Pentek Filtration. This data does not imply any warranty or performance guarantee. We recommend that the user determine performance by testing on his own processing equipment. We assume no liability or responsibility for patent infringement resulting from the use of this product.

**CAUTION:** Do not use cartridges on equipment that has an electric conductivity water level indicator.



# Product Water Resistivity vs Gallons Through-put

## Test Conditions

RO FEED WATER .....15 - 20 TDS  
 pH .....6.5 - 7.5  
 CITY FEED WATER .....170 TDS  
 TEMPERATURE .....77 +/- 2°F

## Cartridges

## Flow Rate

- (1) PCF1-10MB .....0.25 GPM
- (2) PCF1-20MB.....0.50 GPM
- (3) BBF1-20MB.....1.25 GPM
- (4) Two PCF1-20MB tested in a series @ 0.50 gpm
- (5) PCF1-20MB with RO feed water @ 0.50 gpm

1 Microsiemen = 1 Microhms/cm

## FDA Grade Resin

### FUNCTION STRUCTURE

Cation .....R-SO<sub>3</sub>-H+

Anion .....AR-N(CH<sub>3</sub>)<sub>2</sub>(C<sub>2</sub>H<sub>4</sub>OH)+OH-

### PHYSICAL FORM

### IONIC FORM

### PERCENT CONVERSION

Hydrogen .....99.9% Minimum

Hydroxide .....95% Minimum

## Applications:

- Circuit Board Printing
- Power Generating Equipment
- Pharmaceutical Use
- Medical/Laboratory Use
- Steam and Humidification
- Breeding Tanks
- Cosmetics
- Lasers
- Steam Processors
- Jet Water Sprayers
- Humidification Systems
- Boiler Make-up Water
- Recirculating/Cooling Towers

**CAUTION:** Filter must be protected against freezing which can causing cracking of the filter and water damage. For drinking water applications, do not use with water that is microbiologically unsafe or of unknown quality without adequate disinfection before or after the system. Do not use cartridges on equipment that has an electric conductivity water level indicator.

**NOTE:** The above resin data is based on information obtained by Pentek Filtration. These data are believed to be reliable but do not imply any warranty or performance guarantee. We recommend that the user determine performance by testing on his own processing equipment. We assume no liability or responsibility for patent infringement resulting from the use of this product. The DI Resin cartridges are being designed for the following performance parameters.

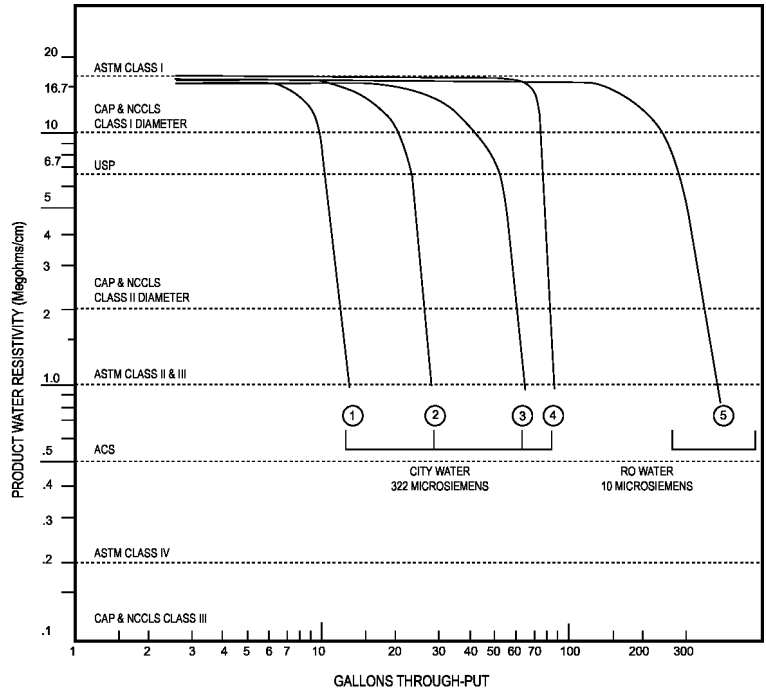

# WS Series Water Softener Cartridges

- Convenient cartridge change-out.
- Manufactured with FDA grade softener resin.
- 750 to 4500 grain capacity available (grains as CaCO<sub>3</sub>).
- For use in Slim Line®, Standard and Big Blue® filter housings.

WS Series cartridges provide softened water in a convenient cartridge-style design.

These cation exchange softening cartridges utilize a bed of sodium form cation resin beads to reduce hardness and scale deposits.

The convenient and space-saving design of our WS Series cartridges means that softened water can be provided easily and cost effectively at the exact point of need.

WS Series cartridges are available in three different sizes and flow rates, and have a rated capacity of 750, 1500 or 4500 grains (as CaCO<sub>3</sub>) capacity.



Item #	Model	Dimensions	Recommended Flow Rate	Capacity (Grains as CaCO <sub>3</sub> )
15531903	WS-10	2- 5/8" x 9-3/4" (6.7cm x 24.8cm)	.50 gpm (1.9 lpm)	750
15532003	WS-20	2-5/8" x 20" (6.7cm x 50.8cm)	.75 gpm (2.8 lpm)	1,500
15532103	WS-20BB	4-1/2" x 20" (11.4cm x 50.8cm)	2.0 gpm (8.5 lpm)	4,500

## Materials of Construction

- **Filter Media** .....Standard Softener Resin\*
- **End Caps** .....Polypropylene
- **Pre-Filter** .....Polypropylene
- **Post-Filter** .....Polypropylene
- **Gasket** .....Buna-N
- **Temperature Rating** .....100°F (37.7°C)

\* Cation, sodium-form resin, 20 x 40 mesh, R-SO<sub>3</sub>-Na+

**WARNING:** For drinking water applications, do not use with water that is microbiologically unsafe or of unknown quality without adequate disinfection before or after the system.

# Freshpoint™ Ultrafiltration System

- Designed for cyst reduction, turbidity, and fine sediment filtration applications.
- > 98% reduction of 0.025 micron (25 nanometer) particles.\*
- > 99.99% (> 4 Log) reduction of 0.065 micron (65 nanometer) particles.\*
- Proprietary hollow-fiber ultrafiltration membrane.
- Professional-grade housing, controller and flush valve.
- Metered self-cleaning cycle flushes only when needed.
- Day override feature flushes module daily with fresh water when system is not in use.
- Peak flow rates up to 10 gpm (2271 L/h).
- Forward-flush and back-flush cleaning cycles provide extended filter life in a wide range of applications.

\*Performance based on MS-2 (25 nm) and PRD-1 (65 nm) virus particle tests. Data available upon request.

The PENTEK® Freshpoint™ Ultrafiltration System provides complete point-of-entry (POE) filtration proven to reduce turbidity, particulates and cysts for safer, cleaner water at every tap. The system employs hollow-fiber Ultrafiltration membrane technology to filter impurities as small as 0.025 microns.

To maximize membrane capacity and service life, a metered flushing cycle is controlled using an advanced controller and high-performance turbine meter. The self-cleaning forward and back-flush cycles are initiated when the programmed capacity of the membrane is reached. During the backwash, flow is reversed and particles are ejected from the pores of the membrane and flushed to drain. In the forward-flush cycle, service water passes through the capillaries at a high speed, scouring particles from the membrane surface and rinsing them from the system. Since power is only required to flush the system, outages and interruptions will not jeopardize the integrity of membrane or its ability to provide safer, cleaner water.

The advanced electronic controller provides a programmable day override which allows the unit to flush every day with fresh water when the system is not in use. Critical system diagnostics, including totalized flow, instantaneous flow rate, and previous days water usage, are available to optimize flushing cycles and monitor performance.

The high-performance industrial fiberglass housing is pressure rated to 300 psi. Inside the housing, the membrane is sealed with double radial o-rings, minimizing the potential for leak paths. Quick-connect end caps allow the membrane to easily be removed for cleaning or replacement.

The system can be applied to solve “known” water problems including high turbidity, suspended solids, and certain microbiological contaminants. It can also serve as a flushable prefilter to extend the life of media filters downstream.

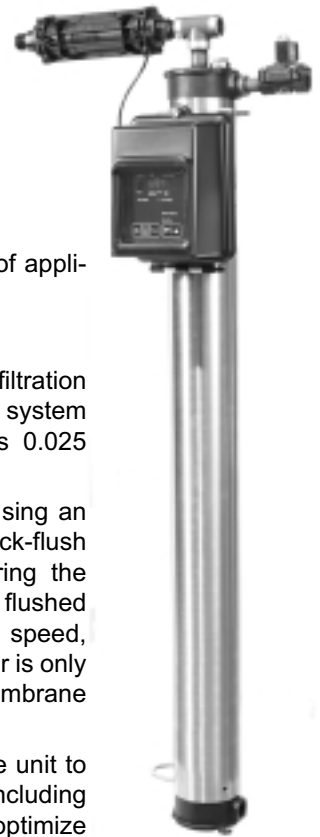

Item #	Model
33145	Freshpoint™ Ultrafiltration System (less controller)
33146	Freshpoint™ Ultrafiltration System (c/w controller)
61595-01	Freshpoint Filter Module Replacement
61667-11	Freshpoint, Backwash Kit c/w ROMate40 Tank 120V
61-667-12	Freshpoint, Backwash Kit w/o Tank, 120V (Tank Req'd)

## Materials of Construction

### MEMBRANE

- **Material** ..... Polyethersulfone, modified (PESM)
- **Pore Size** ..... 0.025 micron (nominal)  
0.065 micron (absolute)
- **Molecular Weight Cut Off** ..... 100-150 kD (MWCO)
- **Active Membrane Surface** ..... 51 sq. ft.
- **Service Flow Rate** ..... 6.23 gpm to 10 gpm  
@ 15 psi drop (1,416 L/h to 2,271 L/h)

### CONTROLLER

- **Electrical Rating** ..... 50/60 Hz
- **Forward Flush Cycle** ..... 1-99 minutes
- **Metered Volume** ..... 1-9999 gallons
- **Meter Accuracy** ..... 1-50 gpm +/- 5%

### SYSTEM

- **Inlet/Outlet** ..... 3/4-inch NPT

This product is not certified as microbiological purifier and should not be applied as stand-alone disinfection solution for microbiologically unsafe water.

