



230 V 50/60 Hz | USC

Automatic pressurisation system with inverter

EN INSTRUCTIONS FOR USE



MADE IN ITALY

 **PEDROLLO**[®]
the spring of life

CONTENTS

GENERAL INFORMATION.....	1
SAFETY REGULATIONS.....	1
TECHNICAL DATA.....	3
APPLICATION LIMITS.....	3
CHARACTERISTIC CURVES.....	3
LUMINOUS SIGNALS	4
INSTALLATION AND HYDRAULIC CONNECTIONS (only for skilled personnel).....	4
FILLING AND SWITCHING ON (only for skilled personnel).....	6
REGULATION OF THE WORKING PRESSURE.....	8
INFLATION UP OF THE VASE (only for skilled personnel)	8
SELECTION OF SELF-PRIMING FUNCTION (only for skilled personnel).....	9
ELECTRIC ATTACHMENTS TO THE EXPANSION CARD (only for skilled personnel).....	9
ALARMS	10
TROUBLE SHOOTING	11
MAINTENANCE (only for skilled personnel)	12
DIMENSIONS (inch).....	13
GUARANTEE	13

GENERAL INFORMATION

Original instructions for use.

This manual must always accompany this device and it must be kept in an accessible place so that the users and those responsible for its maintenance can consult it.

It is recommended that the installer/user should carefully read the specifications and the information contained in the present manual before using the product in order to avoid damage, the improper use of the equipment or the forfeiture of the guarantee.

This product must not be used by children or by persons with a reduced physical, sensory or mental capacity, or by those who lack experience or knowledge, if they have not received the necessary supervision and instruction. Care must be taken to avoid children playing with the device.

The manufacturer does not accept any responsibility in the event of accidents or damage caused by negligence or non-compliance with the instructions contained in this brochure or in conditions which differ from those set out below. Also it does not accept any responsibility for damage caused by the improper use of the pump.

Do not place any weights or other boxes on top of the package.

SAFETY REGULATIONS

In this manual symbols with the following meaning have been used.



This symbol warns that non-compliance with the specifications brings with it the risk of electric shocks.



This symbol warns that non-compliance with the specifications brings with it the risk of harm to persons or damage to property.



BEFORE INSTALLING AND USING THE PRODUCT:

- carefully read this manual in all its parts;
- check that the data on the registration plate are those wanted and suitable for the device;
- installation and maintenance must be carried out by qualified personnel responsible for establishing the electrical connections in accordance with the local rules of installation;

- the manufacturer does not accept any responsibility for damage caused by maintenance or repairs carried out by unqualified personnel and /or by spare parts which are not original;
- the use of spare parts which are not original, tampering or misuse will result in the forfeiture of the guarantee.



DURING THE INITIAL INSTALLATION AND IN CASE OF MAINTENANCE MAKE SURE THAT:

- The power supply has been switched off.
- The power supply is provided with safeguards and in particular a highly sensitive circuit breaker (30 mA in class A) in order to protect from alternating, pulsating unipolar, continuous and high frequency currents due to faults. In addition check that the earthing complies with the required local standards.
- Before removing the lid of the inverter or starting procedures on it the power supply must be disconnected before waiting at least five minutes so that the capacitors have the time to lose their charge through the incorporated discharge resistors.



WARNING: when the DG PED is out of service (red LED flashing) it is still electrically charged. Before any form of intervention on the pump or on the inverter it is obligatory to disconnect the power supply to the pump.



Emergency Stop

- Whilst the DG PED is in operation it is possible to carry out an emergency stop by pressing the I/OON switch.
- In the applications with two units in parallel it is only the MASTER inverter which blocks the system.



During both the first installation and maintenance ensure THERE IS NO POWER in the line.



During both the first installation and maintenance ensure the plant is UNPRESSURED.



DO NOT OPEN THE COVERS OF THE INVERTER except the cover of the connectors.

DESCRIPTION OF THE PRODUCT

DG PED is an automatic pressurisation system with an inverter which integrates: built-in high efficiency self-priming pump, an accumulator tank, pressure and flow rate sensors, a non-return valve.

DG PED is a compact autonomous quiet and high performance pumping system.

A sophisticated electronic control inverter controls the entire system in an intelligent and intuitive manner:

- it maintains the pressure of the installation constant by regulating the velocity of the pump in accordance with the water required;
- it controls the hydraulic and electric operating parameters and protects the pump from abnormalities;
- it can be equipped with an expansion card that makes it possible to work in parallel with other DG PED in the pumping groups and to manage input and output signals;
- it adapts to every type of pressurisation system, including

existing ones. Where the regulations permit it the system is suitable for use with the water supply network. In this case insert a non-return valve upstream;

- it limits the starting and operating currents in order to provide a greater saving of energy.

In the applications in parallel the inverter MASTER and the inverter SLAVE, controlled by the MASTER, stand out.

The MASTER receives the parameter programming details, controls the functional data, and activates and deactivates the SLAVES as necessary.



If the MASTER is switched off, the SLAVES return to being autonomous and continue to work independently.

When it works in a parallel configuration with other inverters, DG PED is able to manage the alternation of the starts in order to harmonise the use of the pumps.

LIST OF PARTS

1. Bipolar general switch I/O
2. Cable hole signals (INPUT/OUTPUT)
3. Control Panel
4. Filling plug
5. Expansion vase plug
6. Vent plug
7. Drain plug
8. Expansion card (OPTIONAL)
9. Fuse 12.5 A (rapid intervention)
10. Connector locking bandwidth
11. Adjustable elbow joint, with OR
12. Discharge outlet
13. Suction port
14. Anti-vibration levelling feet
15. Electricity cable

CONTROL PANEL

16. On/off switch 
17. Green coloured LED indicators that indicate:
 - pump working;
 - working pressure;
 - alarms
18. Green or red LED indicators
19. Switches  and  for changing readings

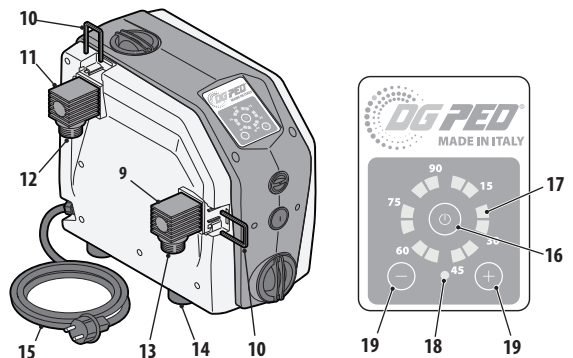
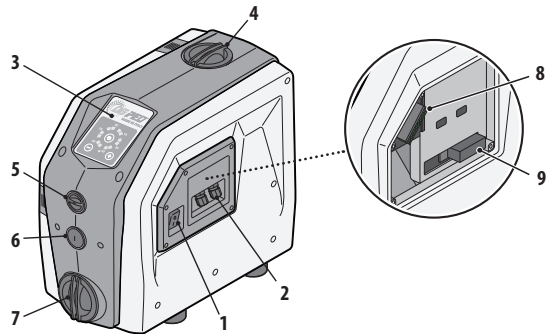

TECHNICAL DATA

- Supply voltage ~ **230 V** ± 10%
- Frequency **50/60 Hz**
- Insulation: **class F**
- Max absorbed current
 - **7.5 A** DG PED 3
 - **10 A** DG PED 5
- P1 Maximum absorbed power:
 - **1.0 kW** DG PED 3
 - **1.5 kW** DG PED 5
- Insulation: class **IP X4**
- Factory set point **45 psi**
- Fuse **12.5 A** (rapid intervention)

APPLICATION LIMITS

- Manometric suction lift up to **26 feet**
- Liquid temperature between **32 °F** and **+104 °F**
- Ambient temperature between **32 °F** and **+104 °F**
- Max. working pressure **145 psi**
- Continuous service **S1**
- Vertical position running



CHARACTERISTIC CURVES

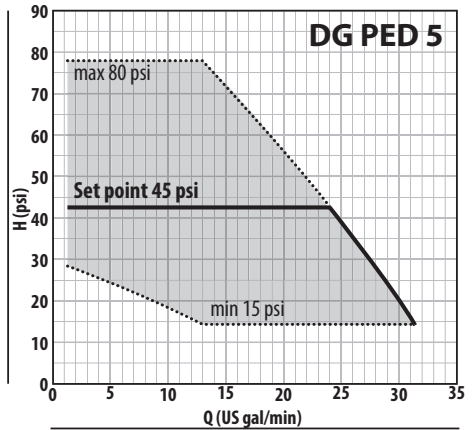
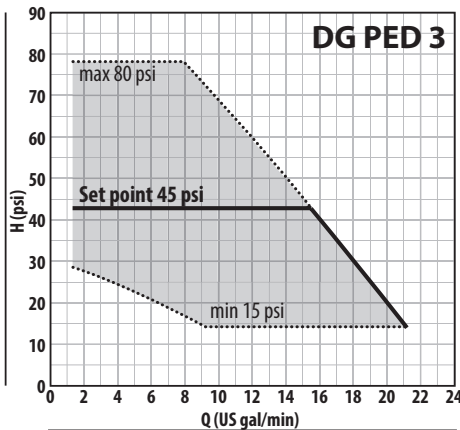

MODEL	POWER		▲	MAX PERFORMANCES		PERFORMANCES (ADJUSTABLE SET POINT)					
	P2	HP		Q	H	Min. Set Point		Set Point Taratura Std		Max. Set Point	
Single-ph.	kW			US gal/min	psi	psi	US gal/min	psi	US gal/min	psi	US gal/min
DG PED 3	0.75	1	IE3	1.5 – 21	78 – 14	15	9.2 – 21	45	1.5 – 15	80	1.5 – 8
DG PED 5	1.1	1.5		1.5 – 32	78 – 14	15	13 – 32	45	1.5 – 24	80	1.5 – 13

Q = Flow rate H = Total manometric head Tolerance of characteristic curves in compliance with EN ISO 9906 Grado 3B.

▲ Three phase motor efficiency class (IEC 60034-30-1)

The performances shown refer to a head in aspiration equal to -3 feet (aspiration of 3 feet). If the water level in aspiration is less than the depth of entrance of the pump the performances will be reduced accordingly.

LUMINOUS SIGNALS

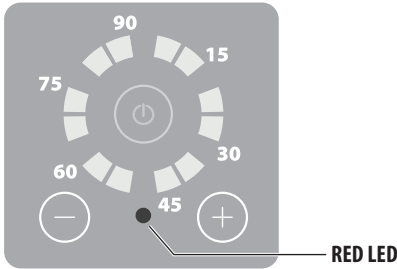

NOT WORKING

DG PED is connected but not working

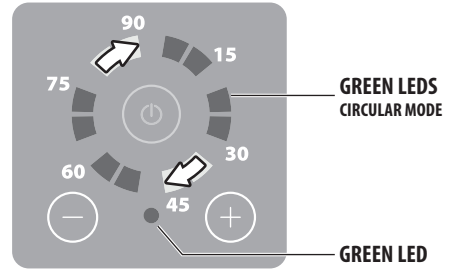

PUMP WORKING

DG PED is connected and the pump is working

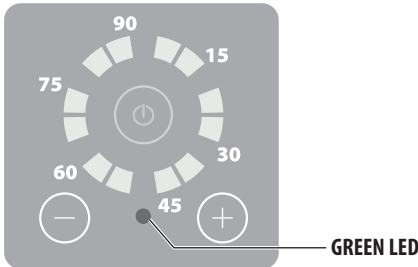

STAND-BY

DG PED is connected but the pump is not working

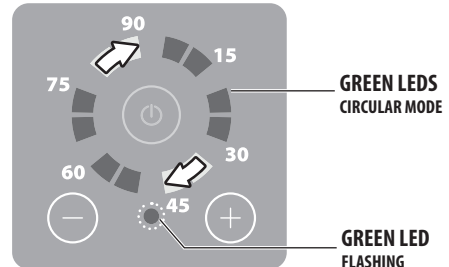

PUMP IN PROCESS OF STOPPING

DG PED is connected and the pump is in process of stopping

INSTALLATION AND HYDRAULIC CONNECTIONS (only for skilled personnel)



During both the first installation and maintenance ensure **THERE IS NO POWER** in the line.



During both the first installation and maintenance ensure the plant is **UNPRESSURED**.

In addition ensure that the electricity supply has protections and in particular has a differential switch of great sensitivity (30 mA in class A) in order to protect from alternating, pulsating unipolar, continuous and high frequency currents due to faults. In addition check that the earthing complies with the required local standards.

Verify that the data on the plate are those desired and that they are adequate for the installation.

Install DG PED in a place:

- protected from external agents;
- ventilated, free of excess humidity or too much dust;
- where it does not suffer from harmful vibrations or mechanical stresses from the tubes connected to it.

- 1 Regulate the levelling feet to correctly level the DG PED.

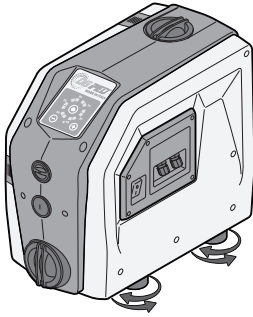

- 2 Remove the covers of the forks.

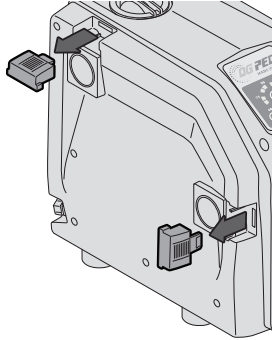

- 3 Remove the forks.

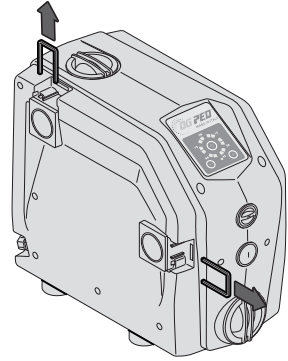

- 4 Insert the elbow fitting complete with O-RING.

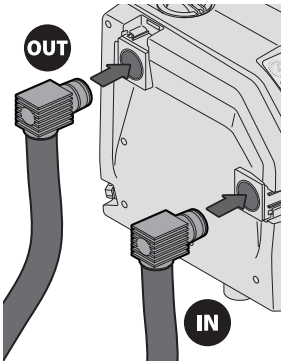

 The aspiration tube must have a minimum diameter of 1" and it must be tightly sealed.

- 5 Correctly insert the forks.

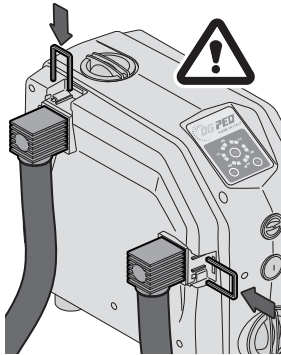

- 6 Insert the fork covers.

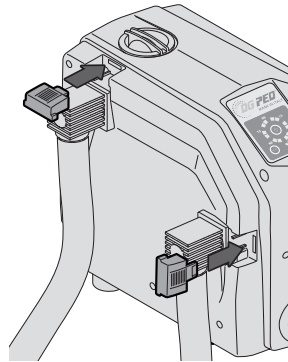

 An expansion vessel can be added to the installation mounted on the delivery side (OUT)

FILLING AND SWITCHING ON (only for skilled personnel)



Never allow the DG PED to run when dry, to avoid damaging the mechanical seal.

CASE A: functioning WHEN BELOW THE WATER (tank or acqueduct)

- 1 Open all the valves to fill the pump with water.

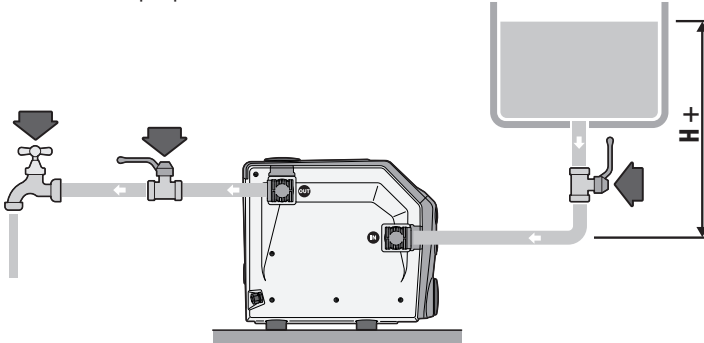

- 2 Attach the plug to the electricity supply.
- 3 Turn the switch to "1".

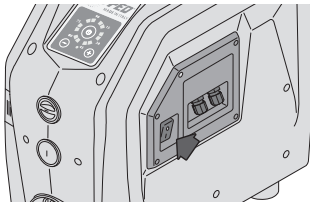

- 4 Press the  switch to switch on the DG PED.

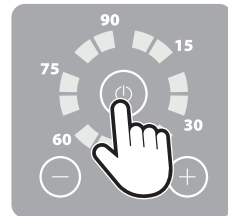

CASE B: functioning when ABOVE WATER (draught from a tank or well)

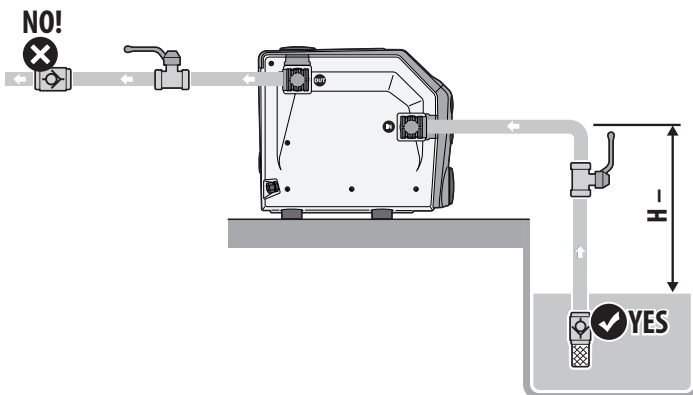

- 1 Unscrew and remove the filling plug and the vent plug.
- 2 Pour in about 1.5 litres of water until it pours out of the vent hole.
- 3 Rescrew the filling plug and the vent plug.
- 4 Open the water tap

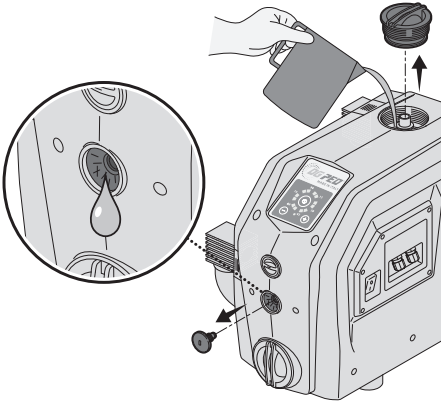

- 5 Attach the plug to the electricity supply.
- 6 Turn the switch to "I".

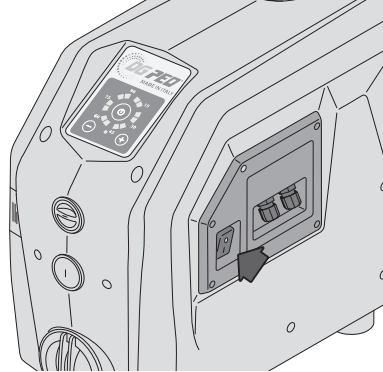

- 7 SIMULTANEOUSLY press buttons ⊕ and ⊖ for 5 seconds. DG PED enters into a priming mode.

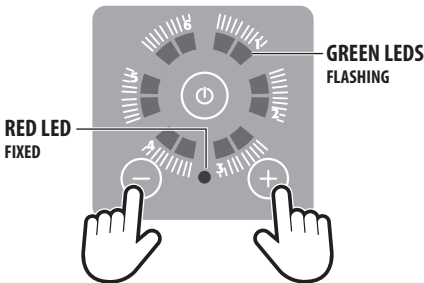

- 8 Press button ⏻ to start priming.

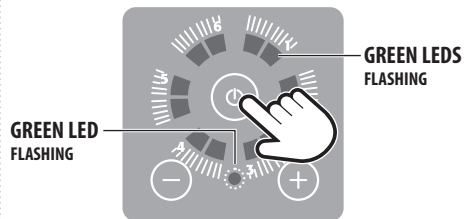

The priming procedure lasts at most 5 minutes, at the end of each minute DG PED automatically stops the electric pump for five seconds then immediately restarts it. This is repeated for all the time the DG PED is priming. During this procedure the LEDS will continue to flash.

The exit from the priming procedure can occur either because of time out (5 minutes) or because it is completed. The LEDS stop flashing. If the pump does not prime repeat the operation from the start.

REGULATION OF THE WORKING PRESSURE

The WORKING PRESSURE is viewed through the green LEDs which are illuminated on the control panel.

The WORKING PRESSURE of the DG PED goes from a minimum of 15 psi to a maximum of 80 psi.

To regulate:

- Press button **+** to view the WORKING PRESSURE.
 - Press buttons **+** or **-** to increase or reduce the WORKING PRESSURE.
- Every time button **+** or **-** is pressed the value increases or decreases in steps of 7.5 psi.

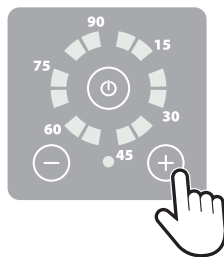

Example

Press button **+** to visualise the WORKING PRESSURE. With the green leds switched on as shown in the diagram the working pressure is **30 psi**.

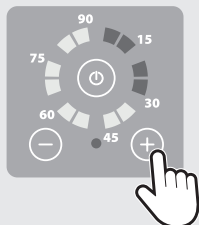

To increase the working pressure to, for example, 45 psi press button **+** twice. The value increases by 15 psi ($7.5 + 7.5$ psi).

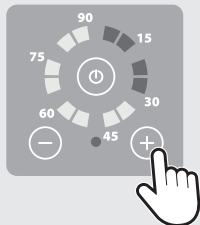

The leds light up as shown in the diagram. Working pressure is **45 psi**.

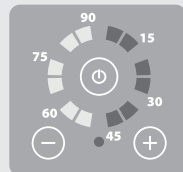

INFLATION UP OF THE VASE (only for skilled personnel)

The expansion vase inside the DG PED is preloaded in the factory to 22 psi.

The optimum inflation of the expansion vessel guarantees the perfect operation of the system and it protects the membrane from premature breakages.

! The inflation of the expansion vessel must be done with an installation pressure of zero. Maximum inflation pressure 58 psi.

! Inflate the expansion vessel as shown in the tablela. For working pressures lower than 45 psi, inflate the vessel by 7.5 psi less than the working pressure.

**Example: working pressure = 30 psi,
inflation pressure = 22 psi**

To inflate the expansion vase:

- Remove the plug.
- Use a compressor.
- Attach the tube of the compressor to the correct valve.
- Inflate the expansion vase to the chosen pressure.

! Check the inflation pressure of the vessel at least once a year. If necessary, restore it to the expected value.

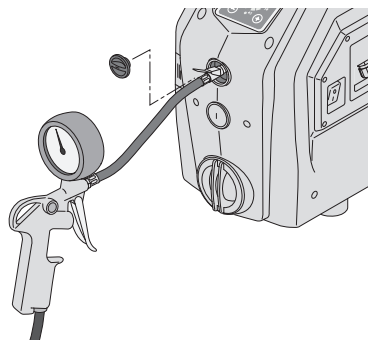

Working pressure	Inflation pressure
45 psi	22 psi
51 psi	29 psi
60 psi	38 psi
65 psi	43 psi
75 psi	53 psi
80 psi	58 psi

SELECTION OF SELF-PRIMING FUNCTION (only for skilled personnel)

The pump leaves the factory as the SELF-PRIMING version; in cases where the negative suction pressure is guaranteed or the feed is already pressurised it is possible to exclude the self-priming function by rotating the lever shown to the vertical position.

- 1 Unscrew and remove the drain plug.
Possible outflow of water.

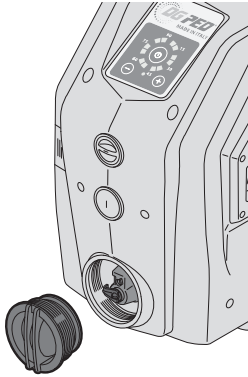

- 2 Rotate the red lever to the vertical position in order to exclude the self-priming function.

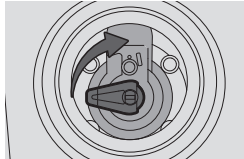

SELF-PRIMING
(factory setting)

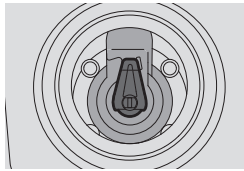

NOT SELF-PRIMING

- 3 Rescrew the drain plug and refill the DG PED with water as described in the FILLING AND SWITCHING ON chapter.

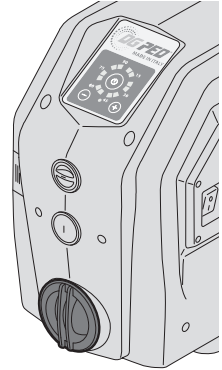

OPTIONAL

ELECTRIC ATTACHMENTS TO THE EXPANSION CARD (only for skilled personnel)



Ensure the electricity supply is SWITCHED OFF.

WARNING: any device connected to the expansion card must be in separated extra-low voltage (SELV).



During removal of the cover do not pull the electric cables connected to the main power switch.

- Unscrew and remove the screws fixing the cover down.
- Partially remove the cover to access the clamps of the expansion card.

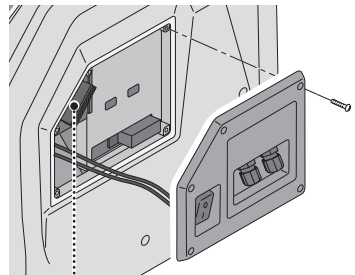

GUIDE TO CLAMPS

- | | | |
|------|--------|---|
| 1-2 | INPUT | INPUT LEVEL SIGNAL-short circuit in absence of a signal |
| 3-4 | OUTPUT | ALARM SIGNAL – max 0.3 A @ 230 Va.c. / 1A @ 30 Vd.c. |
| 5-6 | RS 485 | communication MASTER / SLAVE |
| 7-8 | 0 V | not connected |
| 9-10 | SLAVE | if short circuited the inverter becomes SLAVE |

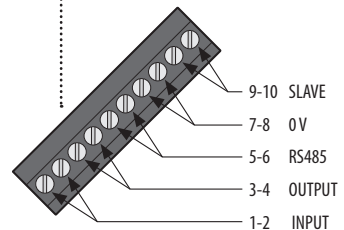

ALARMS

GREEN LED FLASHING + RED LED FLASHING

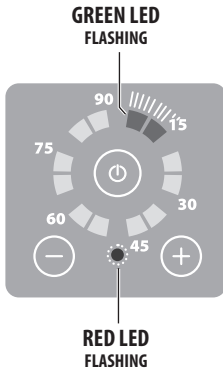

ALARM 1 = Dry running. Set off after 7 sec. of absence of water in suction.

Check the presence of water in aspiration and fill the pump.
 DG PED will effect automatic attempts to restart after 1 min, 15 min, 30 min, 1 h, 1 h, etc.

ALARM 2 = The pump does not reach the set pressure. Contact a repair centre.

ALARM 3 = The pressure of the pre-load of the vase is too low; inflate the vase to 50% of the work pressure (eg. if one works at 45 psi inflate the vase to 22 psi).

ALARM 4 = Discharge pressure less than 3 psi (broken tube), the reset is only manual. Verify why the pressure has fallen to zero.

ALARM 5 = Supply voltage is too low.
 Guarantee an electric current of 230 v. +/- 10%.

ALARM 6 = External OFF signal.

GREEN LED FIXED + RED LED FLASHING

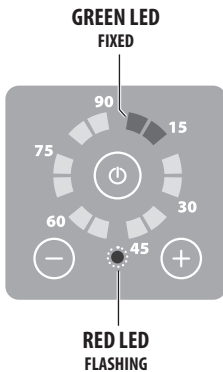

ALARM 1 = Short Circuit. Switch off the device and contact a repair centre.
 Reset is only manual.

ALARM 2 = Too high a current. The current absorbed exceeds the permitted tolerance.
 Reset is only manual. If the problem persists contact a repair centre.

ALARM 3 = Excessive temperature of the module. Check the temperature of the pumped liquid. If the liquid does not have a temperature higher than 104 °F, contact a service center. Automatic reset if the temperature falls below the value of the alarm.

ALARM 4 = Excessive temperature of the motor. If the liquid does not have a temperature greater than 104 °F. contact a repair centre. Control the temperature of the pumped liquid.

Automatic reset if the temperature falls below the alarm setting.

ALARM 5 = Invalid signal of the pressure sensor. Contact a repair centre.

ALARM 6 = Invalid signal of the flow sensor. Contact a repair centre.

Example:
pump in alarm because of DRY RUNNING

LED 1 FLASHING
 +
 RED LED FLASHING
 =
 DRY RUNNING



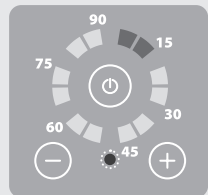

Example:
Pump in alarm because of SHORT CIRCUIT

LED 1 FIXED
 +
 RED LED FLASHING
 =
 SHORT CIRCUIT



TROUBLE SHOOTING

PROBLEM	LED SIGNALS	INTERVENTION
The keyboard does not switch on.	LEDS switched off.	Verify that the lateral switch is in position "I".
		 Verify the electric current switched on, verify the differential switch is suitable.
The pump does not switch on when a consumer seeks to be supplied.	Red LED permanently on.	Switch pump on by pressing the switch "I/O".
	Red LED on and flashing.	See list of alarms in the previous pages.
	Green LED permanently on.	The pressure of the system does not fall below the pressure of the set work.
Alarm of DRY RUNNING.	Red LED flashing Green LEDs in position 1 flashing.	Verify the presence of water in aspiration. Verify the aspiration is not blocked. Fill and prime the pump.
Alarm of SHORT CIRCUIT.	Red LED flashing Green LEDs in position 1 fixed.	 Verify the pump is not blocked by opening the posterior tap of the motor and rotating the shaft.
		 Verify the cable, the plug and the socket are integral and that there are no dispersions.
Alarm of ELECTRIC POWER too low.	Red LED flashing Green LEDs in position 5 flashing.	The voltage is more than 10% inferior to the set value, stabilise the voltage to keep it within the +/-10% limits.
The pump stops and restarts continuously	LED in normal operating condition	Check that the inflation pressure of the vessel is correct. Search for and eliminate leaks in the system.

MAINTENANCE (only for skilled personnel)

INSPECTION AND CLEANING OF THE NON-RETURN VALVE

The NON-RETURN VALVE is positioned inside the suction port.

For removal:

- 1 Remove pressure from the system.
- 2 Remove the cover and fork (A).
- 3 Remove the elbow fitting (B).

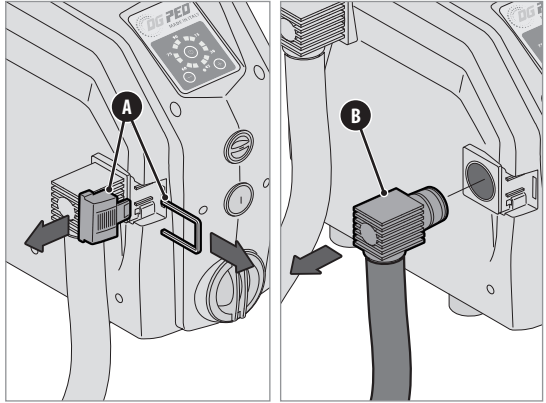

- 4 Extract the NON-RETURN VALVE (C).
- 5 Inspect / clean the NON RETURN VALVE (C).
- 6 Reassemble the NON RETURN VALVE (C) correctly in its seat.
- 7 Reassemble the elbow (B), fork and the cover (A).

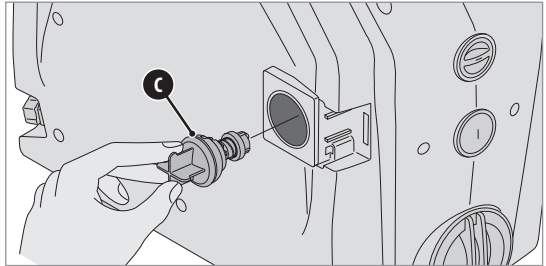

INSPECTION AND CLEANING OF THE FLOW CONTROL VALVE

- 1 **After removing pressure from the system,** unscrew and remove the FILLING PLUG (D).
- 2 Remove the FLOW CONTROL VALVE (E) group by unscrewing the fixing screw. Inspect and clean it.
- 3 Mount the FLOW CONTROL VALVE (E) group. Ensure its orientation is correct!! Re-tighten the retaining screw.
- 4 Correctly screw in the FILLING PLUG (D).

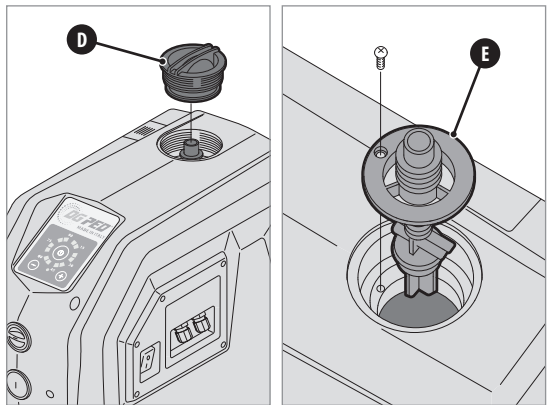

DIMENSIONS (inch)

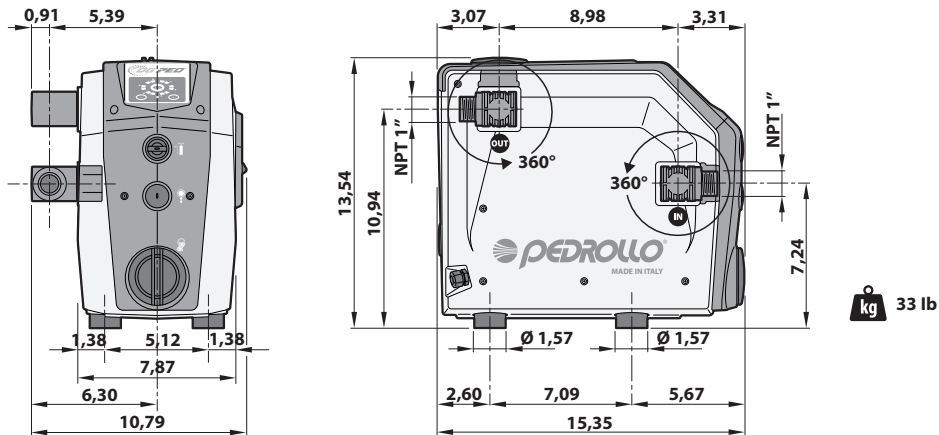

GUARANTEE

Before installing and using the product read all the parts of this manual carefully. The installation and the maintenance must be undertaken by qualified personnel responsible for the hydraulic and electrical attachments in accordance with the applicable current norms.

The manufacturer declines any responsibility for damages caused by an improper use of the product and is not responsible for damages caused by maintenance or repairs carried out by unqualified personnel and/or with non-original spare parts. The use of non-original spare parts, tampering with the product or improper use will result in forfeiture of the guarantee of the product which covers a period of 24 months from the date of purchase.

DISPOSAL

In order to dispose of the parts of which the cards of the DG PED are made you must respect the norms and the laws which are active in the countries where the group is being used.

Do not discard the polluting parts in the environment.



**Correct disposal of WEEE
(DIRECTIVE 2012/19/UE)**

DECLARATION OF CONFORMITY



We hereby declare under our exclusive responsibility, that the product in question results as being in conformity of what is requested by the following European Union Directives, including the latest changes, and by the relevant national laws of implementation:

2006/42/EU, 2014/35/EU, 2014/30/EU, 2009/125/EU, 547/2012/EU, 2011/65/EU, 2015/863/EU, 1907/2006/EU, 2012/19/UE

San Bonifacio, 15/05/2019

Pedrollo S.p.A.
Il Presidente
Silvano Pedrollo



PEDROLLO S.p.A.
Via E. Fermi, 7 37047 – San Bonifacio (VR) - Italy
Tel. +39 045 6136311 – Fax +39 045 7614663
e-mail: sales@pedrollo.com – www.pedrollo.com
